

Chi siamo:

ERREBI è un'azienda che dal 1949 produce nello stabilimento di Cibiana di Cadore (BL) chiavi per serrature. Forte di una tradizione per la chiave che risale al XVIII secolo, Errebi ha saputo svilupparsi nel tempo cogliendo le opportunità di mercato fino a diventare una delle aziende leader nel suo settore. La gamma produttiva si è sviluppata nel tempo. Oltre alle chiavi tradizionali siamo in grado di fornire un'ampia scelta di prodotti tecnologicamente avanzati quali: chiavi transponder, chiavi di sicurezza, macchine duplicatrici altamente sofisticate ed altro ancora.

Alla base del nostro successo sta una lunga esperienza accompagnata da una costante attenzione alla qualità, servizio, innovazione tecnologica e rispetto per l'ambiente.

Non ultimo una grande passione per il nostro lavoro ed un'attenzione particolare alle risorse umane ci completano il profilo.

L'ingresso nel gruppo Altuna (JMA), leader in Europa nel settore chiavi, ci ha infine fornito le sinergie per continuare nel nostro sviluppo e guardare al futuro con grande ottimismo.

Who we are:

Since 1949 ERREBI has produced key blanks for locks at its factory in Cibiana di Cadore (BL).

With a long tradition in key blank manufacturer dating from the XVIII century, Errebi has used its knowledge to develop over time, using market opportunities to become one of the leading companies in its sector. During these years the production range has developed from traditional key blank manufacturing to include today the supply of a wide range of high technology products E.G. transponder keys, high security keys, sophisticated keycutting machines and more.

Errebi's success is based on long experience together with continued and constant care to quality, service, technological innovation and protection of the environment along with a great passion and particular care for its staff.

Lastly, joining the Altuna Group, leader in Europe in the key blanks market, has provided the synergies to continue and enhance our development and look to the future with great optimism.

Qui sommes nous:

ERREBI est une entreprise qui fabrique des clés pour serrures depuis 1949 dans l'usine située à CIBIANA DI CADORE (BELLUNO-Italie).

De plus elle a une grande tradition dans la fabrication de clé à partir du XVIII siècle. ERREBI c'est développée pendant des années, en saisissant les occasions du marché jusqu'à devenir un des leaders dans le secteur de la clé.

Notre gamme de produits s'est élargie au fil des années et offre désormais les clés traditionnelles mais aussi les clés de voiture avec transpondeur, clés de sécurité et les machines à clés reproductives les plus sophistiquées.

Nous devons notre succès à une longue expérience ainsi qu'une continue attention à la qualité, au service, à l'innovation technologique et au respect de

l'environnement, ainsi qu'une grande passion pour notre travail et une attention particulière aux ressources humaines.

L'entrée dans le groupe ALTUNA, leader européen, nous a enfin fourni les synergies pour poursuivre notre essor et nous tourner vers l'avenir avec beaucoup d'optimisme.

Wir über uns:

Die Firma ERREBI spa produziert seit 1949 im italienischen Stammwerk in Cibiana di Cadore (BL) Schlüssel für verschiedene Schlosshersteller und für Schlüsseldienste in der ganzen Welt.

Eine langjährige Tradition, die bis auf das 18. Jahrhundert zurückgeht, hat dazu beigetragen, sich stetig weiterzuentwickeln und auf dem Markt eine führende Firma in dieser Branche zu werden.

Neben traditionellen Schlüsseln bieten wir auch eine große Auswahl an technologisch hochentwickelten Produkten wie Transponderschlüssel, Sicherheitsschlüssel, moderne Schlüsselfräsmaschinen und einiges mehr an.

Unser Erfolg basiert auf langjähriger Erfahrung, sowie ständigen Verbesserungen in Qualität, Kundenservice, technischen Neuerungen und einem Bewusstsein für die Umwelt. Unser Profil wird nicht zuletzt auch durch große Leidenschaft für unsere Arbeit und durch eine besondere Aufmerksamkeit gegenüber unseren Mitarbeitern vervollständigt.

Der Eintritt in die ALTUNA Gruppe, marktführend im Bereich der Schlüsselproduktion in Europa, hat uns die nötigen Synergien geliefert, um unsere Entwicklung fortzusetzen und der Zukunft mit großem Optimismus entgegen zu sehen.

ERREBI®



CERTIFICATO ISO 9001:2008



AFNOR Spain AFAD AFNOR France ABN-Vincent International Belgium ANCI Mexico APCR Portugal CISO Italy CQC China
 COM China CCR Czech Republic CCR Cert Centre DQS Germany DIN Denmark ELIOT Greece FCV Brazil
 FINDERKEMA Venezuela HANABE Hong Kong IAF India IAFI India IAFI India IAFI India IAFI India IAFI India
 IRAM Argentina ICA Japan KQI Korea MZT Hungary NABAS AS Norway NSAI Ireland PNIC Poland QMI Canada
 Quality Austria Austria BQ Bureaus SAI Global Australia SII Israel SRII Slovenia NREMI QAS International Malaysia
 SQS Switzerland SPAC Romania TEST in Peninsular Russia TEGI Serbia
 *The list of I Net members is valid at the time of issue of this certificate. Technical information is available under www.iqnet-certification.com

CHIAVI

TRANSPONDER











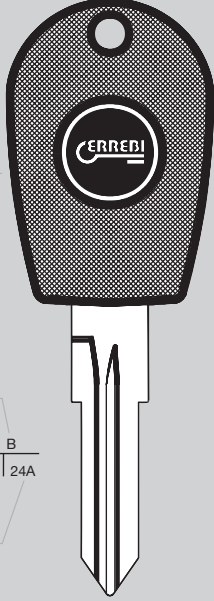

SCATOLA DA 5 PEZZI
EACH BOX CONTAINS 5 KEYS

15

PER/FOR

ALFA ROMEO

 <p>1</p> <p>2</p> <p>3</p> <p>4</p> <p>B S 24A</p> <p>W... 1-9640</p> <p>GB14RPB</p> <p>GIOBERT-TRW-SIPEA</p>									
	<p>T01</p> <p>T05</p>	<p>GB14RPB</p>	<p>←</p>	<p>145</p> <p>146</p> <p>155</p> <p>GTV</p> <p>SPIDER</p>	<p>'95 →</p> <p>'95 →</p> <p>'95 →</p> <p>'95 →</p> <p>'95 → '03</p>	 			
5	6	7	8	9	10	11	12	13	14

1  CHIAVE ERREBI DISPONIBILE
Errebi Key: available

 CHIAVE ERREBI NON DISPONIBILE
Errebi Key: not available

2 TESTA
Head

3 MATERIALE S=ACCIAIO / B=OTTONE / N=ALPACCA
Material S=STEEL / B=BRASS / N=NICKEL SILVER

4 CATEGORIA LISTINO
Price-list Group

5 PROFILO ORIGINALE/SERIE
Original Profile / Code

6 PROFILO
Profile

7 ARTICOLO ERREBI
Errebi Item

8 MARCA PRINCIPALE
Main Brand

9



CODICE TRANSPONDER ERREBI
Errebi Transponder code

T... Transponder

T... Transponder Crypto

ORIGINAL Chip non fornibile / *Chip not available*

T01 PHILIPS

T02 TEMIC

T03 TEXAS CRISTAL

T04 TEXAS CERAMICA

T05 NOVA

T06 TEXAS CRYPTO CRISTAL

T08 MEGAMOS CRYPTO CRISTAL

T09 PHILIPS CRYPTO

T10 PHILIPS CRYPTO

T11 MEGAMOS CRYPTO CERAMICA

T12 PHILIPS CRYPTO

T13 PHILIPS CRYPTO

T14 PHILIPS CRYPTO

T15 PHILIPS CRYPTO

T16 PHILIPS CRYPTO

T19 TEXAS CRYPTO CERAMICA

T20 TEXAS CRYPTO CERAMICA

T21 TEXAS CRYPTO

T22 MEGAMOS CRYPTO

T23 MEGAMOS CRYPTO

T24 MEGAMOS CRYPTO

T25 MEGAMOS CRYPTO

T26 TEXAS CRYPTO

T27 TEXAS CRYPTO

T28 TEXAS CRYPTO

T29 TEXAS CRYPTO

T30 TEXAS CRYPTO

T31 TEXAS CRYPTO

T32 SOKIMAT CRYPTO

TX1

TX2

TX3

TX4

10



ARTICOLO ERREBI ACCENSIONE
Errebi Key Model IGN ON

11



← APERTURA PORTE=ACCENSIONE
TO OPEN DOORS = IGN ON
SOLO APERTURA PORTE
ONLY TO OPEN DOORS
T00.....

12



MODELLO VEICOLO
Car Model

13



FABBRICATO DAL.... AL...
In Production fromuntil...

14



COPIA ESEGUIBILE CON LS5-LS6-LS7-LS8
Copy of Key By LS5-LS6-LS7-LS8



LS7 - LS8

COPIA ESEGUIBILE SOLO CON LS7-LS8
Copy of Key Only By LS7-LS8

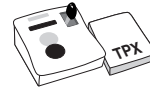

LS7 + TPX
LS8

COPIA ESEGUIBILE
CON LS7+TPX clonner / LS8
*Copy of Key
by LS7+TPX Clonner / LS8*

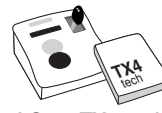

LS7 + TX4 tech
LS8

COPIA ESEGUIBILE
CON LS7+TX4 TECH / LS8
*Copy of Key
by LS7+TX4 Tech / LS8*



COPIA ESEGUIBILE CON TRACK 7
Copy of Key By TRACK 7

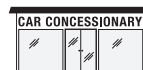

COPIA ESEGUIBILE SOLO
DA CONCESSIONARIO

*Possible to copy
only by car-concessionary*

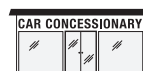

(*****) Pin code

COPIA ESEGUIBILE SOLO DA
CONCESSIONARIO CON IMMISSIONE
PIN CODE CASA AUTOMOBILISTICA

*Possible to copy
only by car-concessionary
+ original brand pin code*



ESEGUIRE ISTRUZIONI
LIBRETTO VEICOLO

See auto instructions

15

MARCA VEICOLO
Car Brand

Sommario / Index



Auto da 9 a 176
Cars



Camion da 179 a 186
Trucks

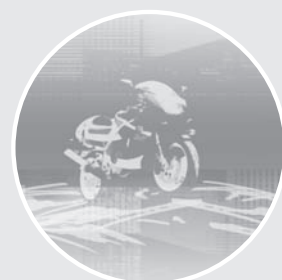

Moto da 189 a 200
Motorcycles



Auto
Cars

ACURA

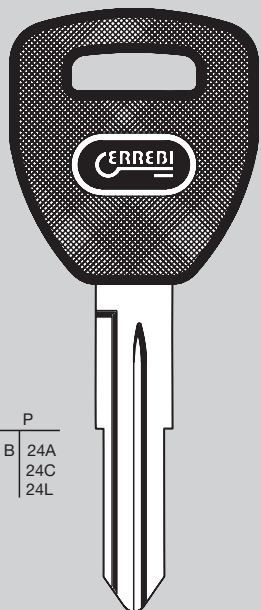

P
B | 24A
24C
24L

...5001-8442



HD43RP

HONDA

T02 T05	HD43RP	←	3.5 RL CL & TL INTEGRA MD-X NSX RSX	'97 → '99 → '00 → '01 → '97 → '02 →	
T08	HD43RP	←	TSX	'03 → '04	
TX4	HD43RP	←	RL TSX	'05 → '04 → '08	

ACURA

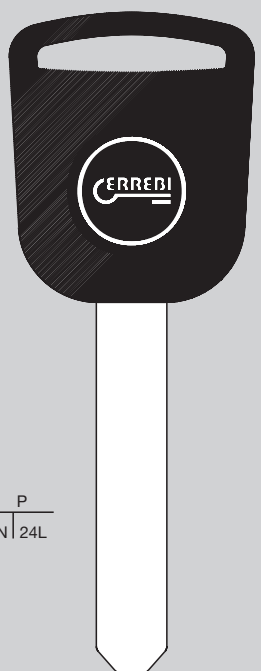

P
N | 24L

...
K001-N718



HD58P

HONDA

TX4	HD58P	←	CSX MD-X RDX RL TL TSX ZDX	'06 → '07 → '06 → '05 → '04 → '09 → '11 →	

ALFA ROMEO

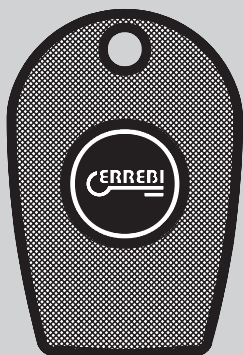

B
B | 24A

W....
1-9640

GB14RPB

GIOBERT-TRW-SIPEA

T01	GB14RPB	←	145	'95 →	
T05			146	'95 →	
			155	'95 →	
			GTV	'95 →	
			SPIDER	'95 → '03	

ALFA ROMEO

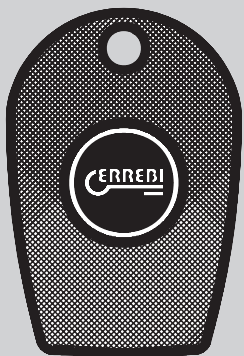

B
B | 24A

K....
H....
7001-8092

SP28PB

TRW-SIPEA

T01	SP28PB	←	164	'95 →	
T05					

ALFA ROMEO

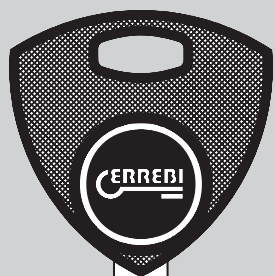

A
B | 24B

...1-17735

GB17RPA

GIOBERT-TRW-SIPEA

T01	GB17RPA	←	164 Plus	'97 →	
T05					

ALFA ROMEO



P
B | 23B

GB18P

GIOBERT-TRW-SIPEA

ORIGINAL		T00GB18P	147 156 159 166 BRERA GT SPIDER	'01 → '98 → '01 '05 → '98 → '04 '05 → '04 → '06 →	

ALFA ROMEO



P
B | 24L

GB18P

GIOBERT-TRW-SIPEA

TX4	GB18P		156 166 CROSSWAGON GIULIETTA MITO	'01 → '04 → '00 → '06 '10 → '08 →	 LS7 + TX4 TECH LS8

ALFA ROMEO

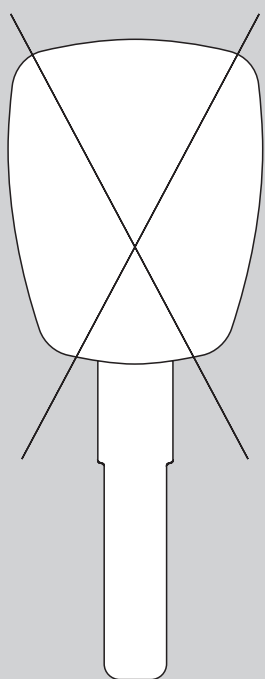

ORIGINAL

			8C COMPETIZIONE CROSSWAGON	'07 → '07 →	 CAR CONCESSIONARY

AUDI



A
S | 24A



AH....
1-8154
1001-9282

HF44PA

HUF

T02	HF44PA	←	80	'95 →	
T05			90	'95 →	
			A4	'95 →'96	
			A6	'95 →'96	
			A8	'95 →'96	
			CABRIO	'95 →'96	
			COUPE'	'95 →'96	
			S6	'95 →'96	
			SPIDER	'95 →'96	

AUDI



A
B | 24B



AH....
1-8154
1001-9282

HF55PA

HUF

T02	HF55PA	←	A3	'96 →'97	
T05			A4	'96 →'97	
			A6	'96 →'97	
			A8	'96 →'97	
			CABRIO	'96 →'97	
			COUPE'	'96 →'97	
			S6	'96 →'97	

AUDI

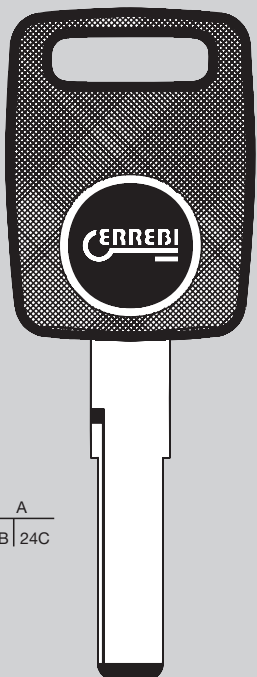

A
B | 24C

AH...
1-8154
1001-9282

HF55PA

HUF

T08	HF55PA	←	A2 A3 A4 A6 A8 ALLROAD COUPE' CABRIO S3 S4 S6 S8 TT	'99 → '97 →'04 '97 →'04 '97 →'04 '97 →'04 '00 →'04 '97 → '97 → '99 → '99 → '97 →'04 '97 →'04 '98 →'04	 TRACK 7

AUDI

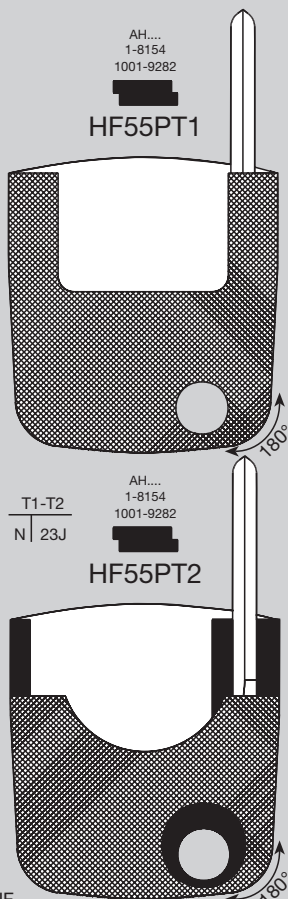

AH...
1-8154
1001-9282

HF55PT1

T1-T2
N | 23J

AH...
1-8154
1001-9282

HF55PT2

HUF

ORIGINAL	T00HF55PT1		A2	'00 →	 CAR CONCESSIONARY
	T00HF55PT2		A3	'00 →'04	
			A4	'00 →'04	
			A6	'00 →'04	
			A8	'00 →'04	
			ALLROAD	'00 →'04	
			COUPE'	'00 →	
			CABRIO	'00 →	
			S3	'99 →	
			S4	'99 →	
			S6	'00 →'04	
			S8	'00 →'04	
			TT	'00 →'04	

AUDI

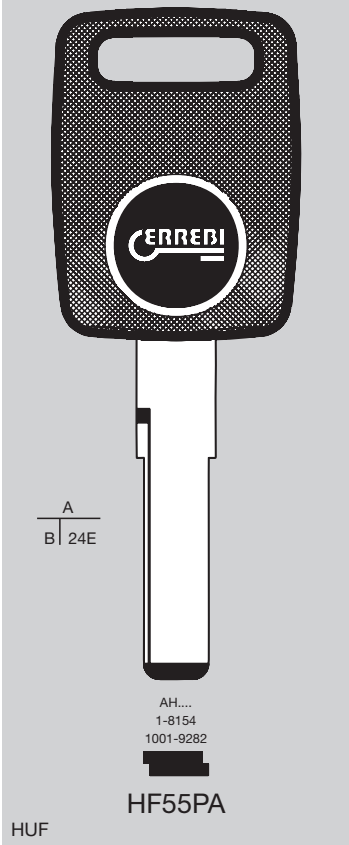

T25	HF55PA	←	A1 A3 A4 A5 A6 A8 (☼) ALLROAD Q5 Q7 (☼) TT	'08 → '04 → '05 → '07 → '04 → '04 → '06 → '08 → '06 → '05 →	 (****) Pin code
					* LS7+TX4 TECH LS8

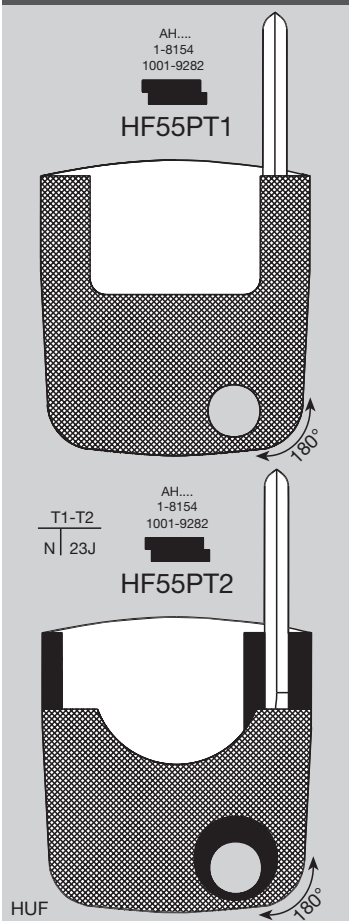

AUDI



ORIGINAL		T00HF55PT1 T00HF55PT2	A3 A4 A5 A6 A8 ALLROAD Q5 Q7 TT	'04 → '05 → '07 → '04 → '04 → '06 → '08 → '06 → '05 →	 (****) Pin code

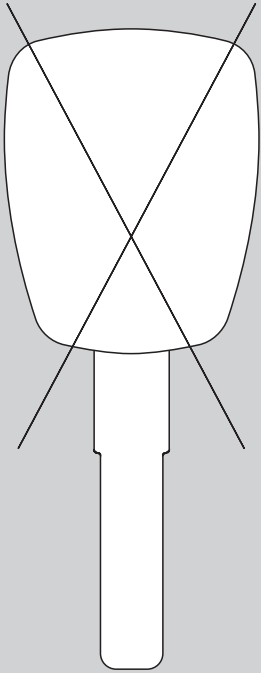





AUDI

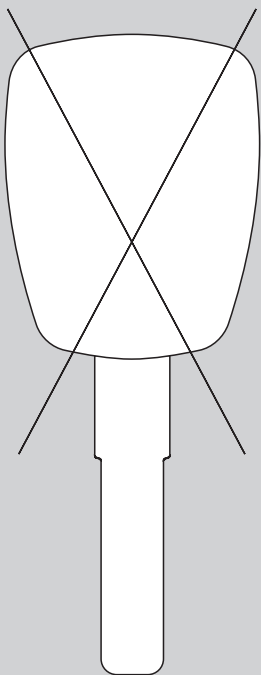

					
ORIGINAL			R8	'07 →	

BENTLEY

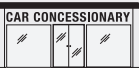

					
ORIGINAL			ARNAGE CONTINENTAL GT CONTINENTAL GTC CONTINENTAL FLYING	'06 → '06 → '06 → '06 →	

BMW

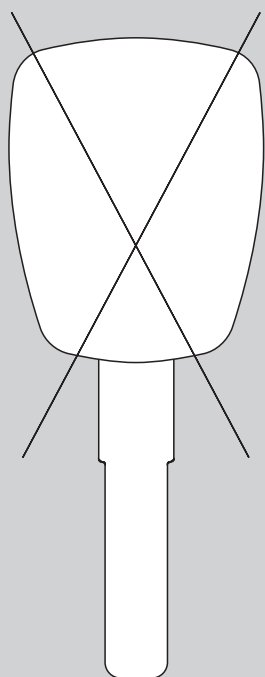

ORIGINAL			Serie 1	'04 →	
			Serie 3	'95 →	
			Serie 5	'95 →	
			Serie 6	'04 →	
			Serie 7	'95 →	
			X1	'09 →	
			X3	'04 →	
			X5	'00 →	
			X6	'08 →	
			Z3	'95 →	
		Z4	'02 →		
		Z8	'02 →		

BUICK

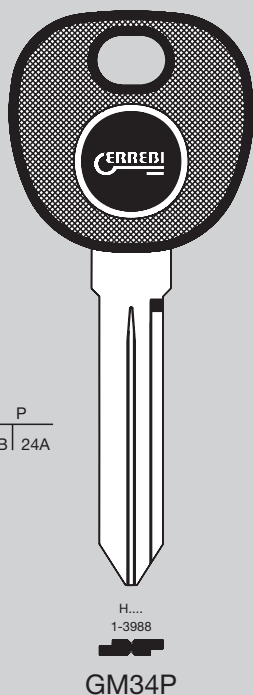

T05	GM34P	←	CENTURY	'00 →	
			LE SABRE	'00 →	
			PARK AVENUE	'00 →	
			RANIER	'03 → '04	
			RENDEVOUZ	'01 → '05	
			ROADMASTER	'01 → '05	

BUICK

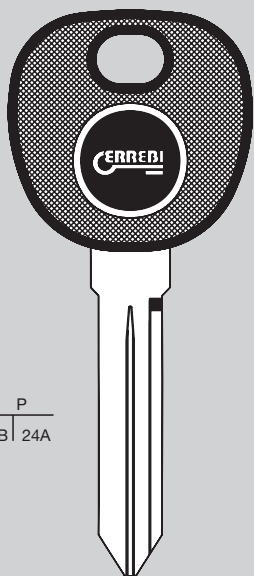

P
B | 24A

...A00-7N45
GM35P

G.M.

T05	GM35P	←	CENTURY LE SABRE PARK AVENUE RENDEVOUZ TERRAZA	'00 → '00 → '00 → '06 → '05 →	

BUICK

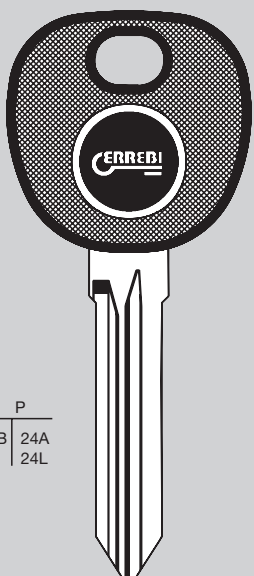

P
B | 24A
24L

GM36P

G.M.

T05	GM36P	←	ALLURE LACROSSE RANIER TERRAZA	'05 → '09 '05 → '03 → '05 →	
TX4	GM36P	←	ENCLAVE LUCERNE	'07 → '06 →	 LS7 + TX4 TECH LS8

BUICK

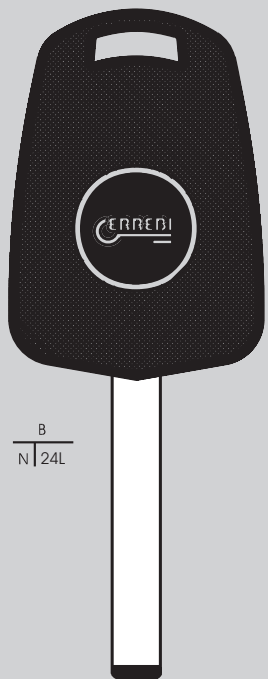

B
N | 24L

HF66PB

HUF

TX4	HF66PB	←	ALLURE LACROSSE REGAL VERANO	'10 → '10 → '11 → '12 →	 LS7 + TX4 TECH LS8

CADILLAC



P
B | 24A

S...
1-5200
HF43P

HUF

T01 T05	HF43P	←	CATERA	'97 →'99	

CADILLAC

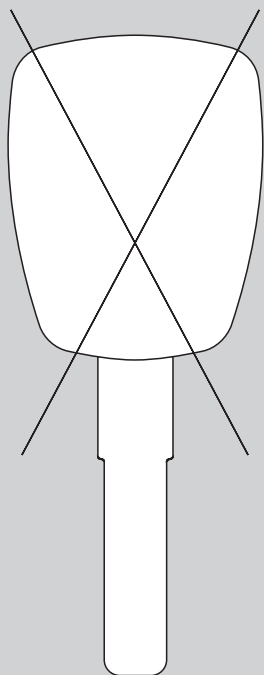

ORIGINAL			BLS BLS STATION CTS CTS-V XLR	'06 → '07 → '03 → '03 → '04 →	

CADILLAC

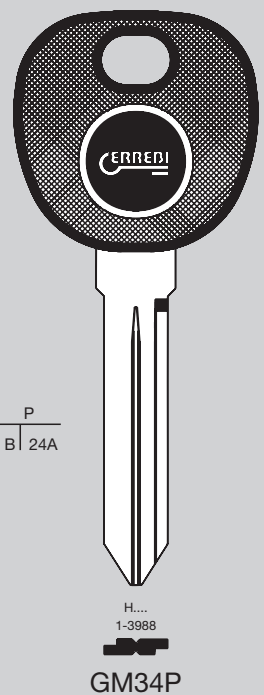

T05	GM34P	←	DEVILLE DORADO S5S SEVILLE STS	'00 → '00 → '00 → '00 → '00 →	

CADILLAC

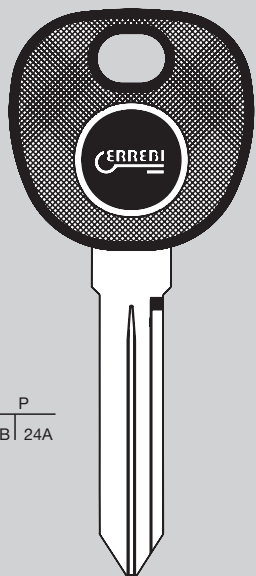

P
B | 24A

...A00-7N45
GM35P

G.M.

T05	GM35P	←	DEVILLE DORADO S5S SEVILLE	'00 → '00 → '00 → '00 →	

CADILLAC

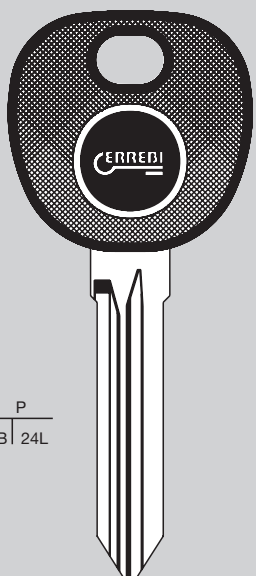

P
B | 24L

GM36P

G.M.

TX4	GM36P	←	CTS DTS ESCALADE SRX STS	'08 → '05 → '07 → '07 → '08 →	 LS7 + TX4 TECH LS8

CHEVROLET



P
B | 24A



J...
1-1200
DW2RP
DW2P

DAEWOO

T05	DW2RP	←	VIVANT	'04 →	
T05	DW2P	←	EPICA	'04 →	
T08	DW2RP	←	AVEO	'04 →	 TRACK 7

CHEVROLET



P
B | 24A

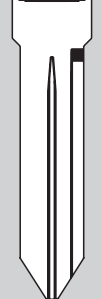

H...
1-3988
GM33P

G.M.

T05	GM33P	←	AVANLACHE CAMARO CAVALIER CORVETTE INPALA MALIBÙ VENTURE	'01 → '06 '99 → '99 → '99 → '99 → '05 '99 → '03 '99 →	

CHEVROLET

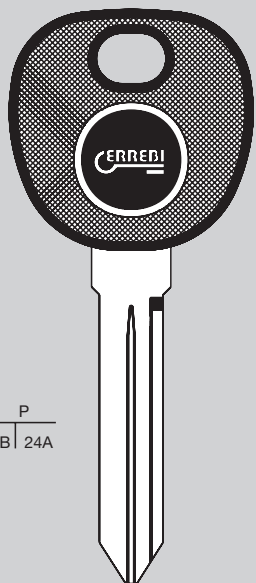

P
B | 24A

H...
1-3988
GM
GM34P

G.M.

T05	GM34P	←	MONTECARLO	'00 → '05	

CHEVROLET

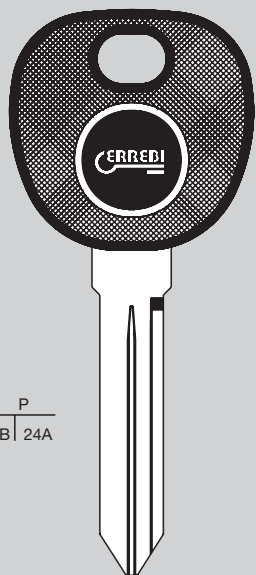

P
B | 24A

...A00-7N45
GM
GM35P

G.M.

T05	GM35P	←	CAMARO CAVALIER CORVETTE INPALA MALIBÙ MONTECARLO UPLANDER VENTURE	'99 → '99 → '99 → '99 → '05 '99 → '03 '00 → '05 '05 → '99 →	

CHEVROLET

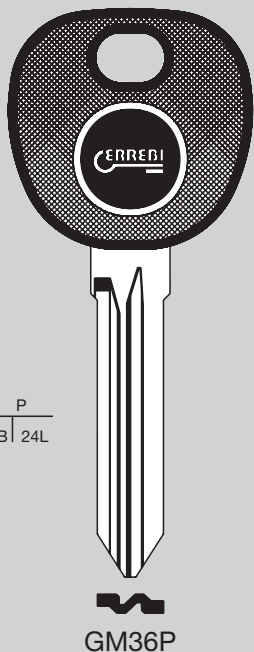

P
B | 24L

GM36P

G.M.

TX4	GM36P	←	AVANLACHE COBALT EQUINOX EXPRESS HHR IMPALA MALIBÙ MONTECARLO SILVERADO SUBURBAN TAHOE TRAVERSE	'07 → '06 → '06 → '09 '08 → '06 → '06 → '04 → '06 → '07 → '07 → '07 → '09 →	 LS7 + TX4 TECH LS8

CHEVROLET

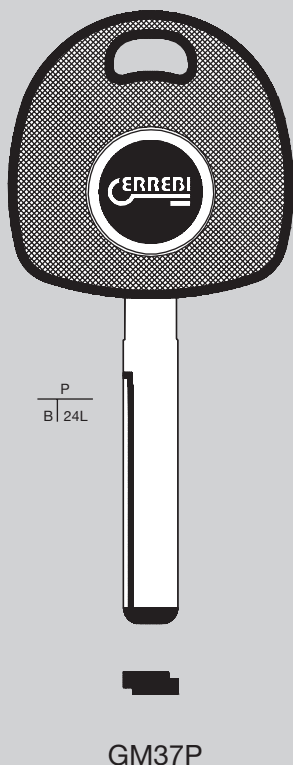

P
B | 24L

GM37P

G.M.

TX4	GM37P	←	LUMINA SEDAN LUMINA UTE	'10 → '10 →	 LS7 + TX4 TECH LS8

CHEVROLET

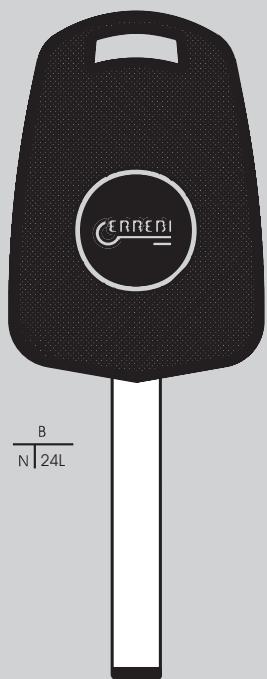

B
N | 24L

HF66PB

TX4	HF66PB	←	CAMARO CRUZE EQUINOX SONIC VOLT	'10 → '11 → '10 → '12 → '11 →	 LS7 + TX4 TECH LS8

CHEVROLET

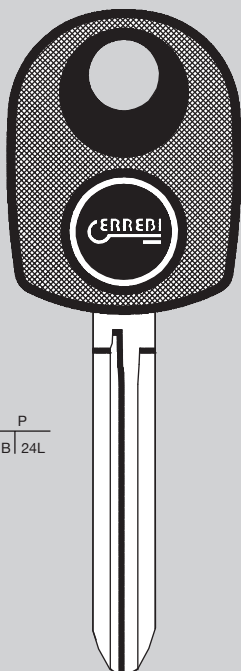

P
B | 24L

TY37P

TX4	TY37P	←	COLORADO	'08 →	 LS7 + TX4 TECH LS8

CHEVROLET



P
B | 24C



TY37PA

(T08)	TY37PA	←	COLORADO	'08 →	 TRACK 7

CHEVROLET (UE)



P
B | 24C
23A

J....
1-1200

DW2RP



DW2P

DAEWOO

(T08)	DW2RP	←	NUBIRA TACUMA	'00 → '05 '00 → '05	 TRACK 7
(T08)	DW2P	←	MATIZ	'01 →	
(TX2)	DW2RP	←	LACETTI NUBIRA SW	'04 → '04 →	 LS7 + TPX LS8

CHEVROLET (UE)



P
B | 24C
24L



DAEWOO

T08	DW1RP	←	LEGANZA	'00 →	 TRACK 7
TX4	DW1P	←	CAPTIVA	'06 →	 LS7 + TX4 TECH LS8
TX2	DW1P	←	EPICA EVANDA	'06 → '03 →	 LS7 + TPX LS8

CHEVROLET (UE)

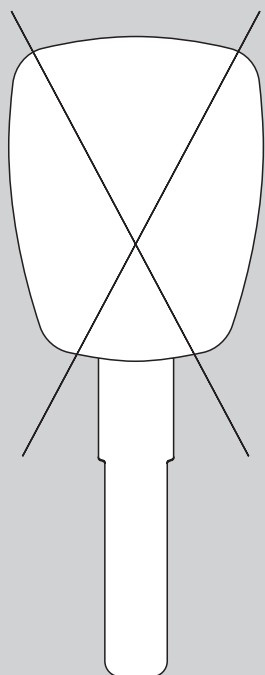

ORIGINAL			AVEO KALOS LANOS LEGANZA	'06 → '02 → '02 → '02 →	

CHEVROLET (UE)

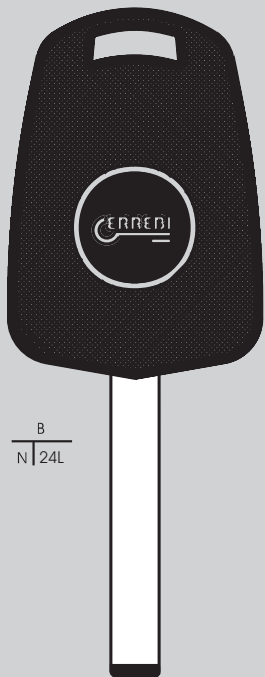

B
N | 24L

HF66PB

HUF

TX4	HF66PB	←	CRUZE	'08 →	 LS7 + TX4 TECH LS8

CHRYSLER

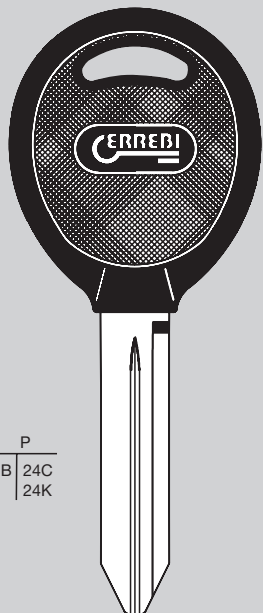

P
B | 24C
24K

L...
1-3580
CY62P

CHRYSLER

T06	CY62P	←	300 300M CONCORDE LHS NEW YORKER NEON	'98 → '04 '98 → '98 → '98 → '01 → '98 →	 LS7 + TPX LS8
TX2	CY62P	←	PROWLER PT CRUISER STRATTUS TOWN & COUNTRY VISION	'00 → '00 → '05 '99 → '01 → '03 '98 →	

CHRYSLER

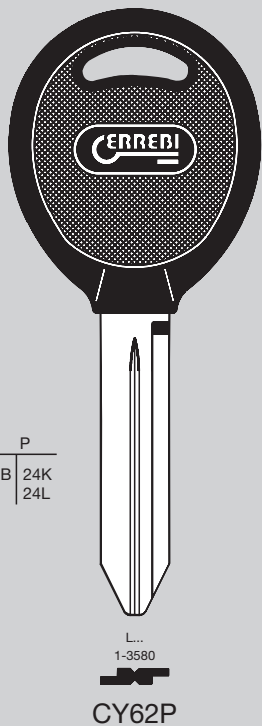

CHRYSLER

TX2	CY62P	←	CIRRUS GRAND VOYAGER SEBRING VOYAGER	'99 → '98 → '98 → '06 '98 →	 LS7 + TPX LS8
TX4	CY62P	←	200 200C 300 300C ASPEN PACIFICA PT CRUISER SEBRING 4 DOOR SEBRING CONVERTIBLE TOWN & COUNTRY VOYAGER	'11 → '11 → '05 → '05 → '07 → '04 → '06 → '07 → '07 → '07 → '04 → '04 →	 LS7 + TX4 TECH LS8

CHRYSLER

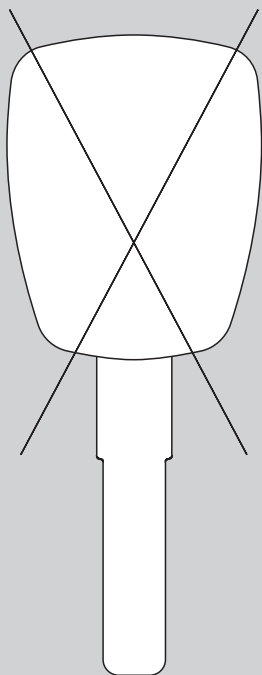

ORIGINAL

			CROSSFIRE	'05 →	

CITRÖEN

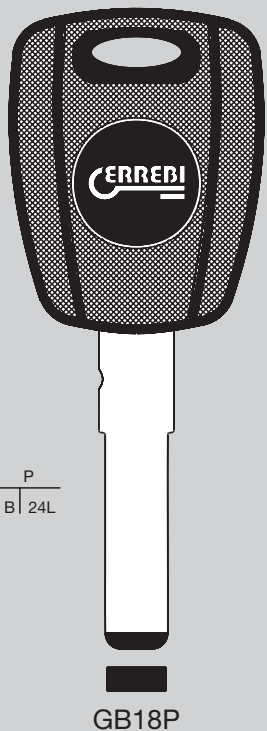

P
B | 24L

GB18P

GIOBERT-TRW-SIPEA

TX4	GB18P	←	JUMPER NEMO RELAY	'06 → '08 → '06 →	 LS7 + TX4 TECH LS8

CITRÖEN



P
B | 24A

N...6001-7000
J...3001-6732
V...1-3051
V...5001-8058
AB...6001-6891

GB9RP

GIOBERT-TRW-SIPEA

T02 T05	GB9RP	←	JUMPER	'96 → '01	

CITRÖEN



P
N | 24L

HF63P

HUF

TX4	HF63P	←	C4 PICASSO C5 C8 DISPATCH JUMPY	'02 → '08 → '02 → '07 → '07 →	 LS7 + TX4 TECH LS8

CITRÖEN



B
B | 24L

30010-32009

MIT8RPB

mitsubishi

TX4	MIT8RPB	←	C-CROSSER	'07 →	 LS7 + TX4 TECH LS8

CITRÖEN



P
N 24B
24C

111111-628888



SM7P

SIMPLEX

T01	SMTP	←	BERLINGO	'98 → '00	
T05			EVASION	'97 →	
			JUMPY	'98 →	
			SAXO	'97 → '00	
			XANTIA	'97 → '98	
			XSARA	'97 → '00	
T08	SM7P	←	XANTIA	'98 →	
T11	SM7P	←	JUMPER	'01 → '05	
			XANTIA	'98 →	TRACK 7

CITRÖEN



P
N 24D

111111-628888



SM7P

SIMPLEX

TX4	SM7P	←	BERLINGO	'00 → '02	
			C5	'01 → '05	
			DISPATCH	'02 → '06	
			JUMPY	'02 → '06	
			SAXO	'00 →	
			XSARA	'01 →	
			XSARA PICASSO	'01 →	

CITRÖEN



P
N | 24L
24K

VA1P

VALEO

TX4	VA1P	←	BERLINGO C2 C3 C3 PICASSO C4 C5 C6 DS3 DS4	'02 → '03 → '02 → '08 → '05 → '06 →'08 '06 → '10 → '11 →	 LS7 + TX4 TECH LS8
TX2	VA1P		C1	'05 →	 LS7 + TPX LS8

DACIA



P
B | 24L

DCA3RP

DACIA

TX4	DCA3RP	←	SOLENZA	'98 →	 LS7 + TX4 TECH LS8

DACIA

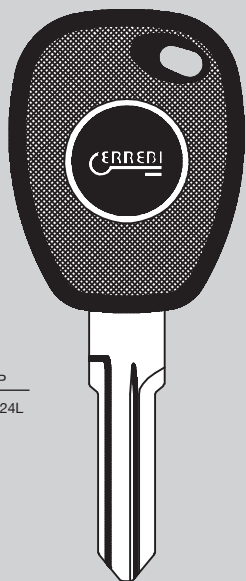

P
B | 24L

DCA4RP

DACIA

TX4	DCA4RP	←	LOGAN	'06 →	 LS7 + TX4 TECH LS8

DACIA



P
B | 24L

...A/Z 0/9
1-4092
5001-9092

VC82P

VACHETTE

TX4	VC82P	←	DUSTER LOGAN LOGAN Mcv SANDERO SYMPOL	'10 → '06 → '07 → '09 → '10 →	 LS7 + TX4 TECH LS8

DAEWOO



P
B 24A
24C
24H
24K



DAEWOO

T02 T05	DW1P	←	LEGANZA	'97 → '00	
T02 T05	DW1RP	←	LANOS	'97 → '02	
(T08)	DW1RP	←	LEGANZA	'00 → '02	 TRACK 7
TX4	DW1P	←	CAPTIVA	'06 →	 LS7 + TX4 TECH LS8
(TX2)	DW1P	←	EPICA EVANDA	'06 → '03 →	 LS7 + TPX / LS8

DAEWOO



P
B 24A
24C
23A



DAEWOO

T02 T05	DW2RP	←	NUBIRA	'97 → '00	
(T08)	DW2RP	←	NUBIRA TACUMA	'00 → '05 '00 → '05	 TRACK 7
(T08)	DW2P	←	MATIZ	'01 → '05	
ORIGINAL		T00DW2RP	LACETTI NUBIRA	'04 → '05 →	 CAR CONCESSIONARY
		T00DW2P	MATIZ	'05 →	

DAEWOO



P
B | 24A



M...
1-1200
DW3P

DAEWOO

T02 T05	DW3P	←	MATIZ	'98 → '01	

DAEWOO

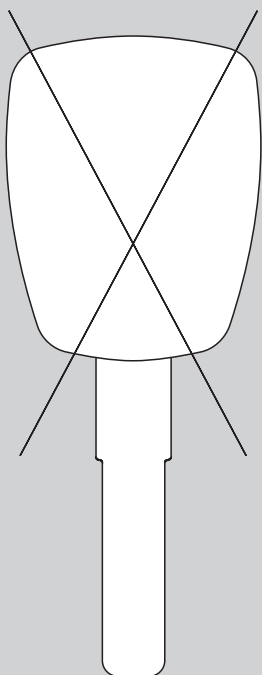

ORIGINAL			KALOS LANOS	'02 → '02 →	

DAIHATSU



P
B | 24H
24K

D...
1-1200
DS2RP

DAIHATSU

TX1	DS2RP	←	CHARADE COPEN CUORE FEROZA SIRION TERIOS YRV	'97 → '10 '02 → '98 → '06 '95 → '98 → '04 '97 → '05 '00 →	 LS7 LS8
TX2	DS2RP	←	CUORE MATERIA SIRION TERIOS TREVIS	'07 → '06 → '05 → '06 → '07 →	 LS7 + TPX LS8

DAIHATSU



P
B | 24H

D...
3001-4000
DS3RP

DAIHATSU

TX1	DS3RP	←	CUORE MOVE	'98 → '06 '97 →	 LS7 LS8

DAIHATSU









P
B | 24K

...1-13284

 TY45P

TOYOTA

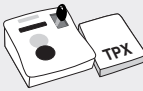
					
TX2	TY45P	←	CHARADE	'11 →	 LS7 + TPX LS8

DODGE









P
B | 24C
 24K

L...
 1-3580

 CY62P

CHRYSLER

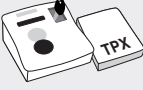
					
T06	CY62P	←	CARAVAN DAKOTA DURANGO INTREPID NEON RAM	'01 → '01 → '01 → '05 '98 → '00 → '00 →	
TX2	CY62P	←	STRATUS	'99 →	 LS7 + TPX LS8

DODGE

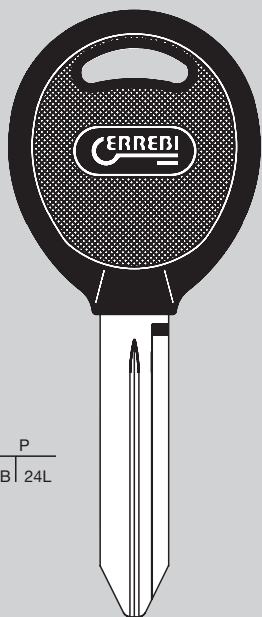

P
B | 24L

L...
1-3580
CHRYSLER
CY62P

CHRYSLER

TX4	CY62P	←	AVENGER CALIBER CARAVAN CHALLENGER CHARGER DAKOTA DURANGO JOURNEY MAGNUM NITRO RAM	'08 → '07 → '04 → '08 → '05 → '05 → '04 → '98 → '05 → '07 → '06 →	 LS7 + TX4 TECH LS8

DODGE

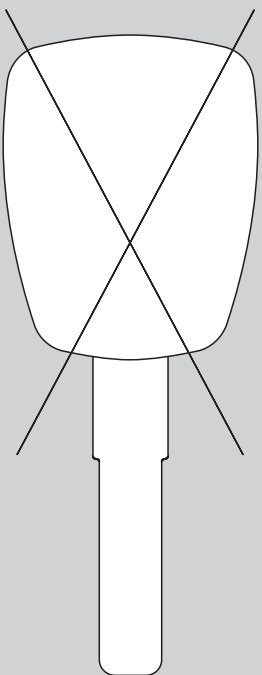

ORIGINAL

			VIPER	'05 →	 CAR CONCESSIONARY

DR

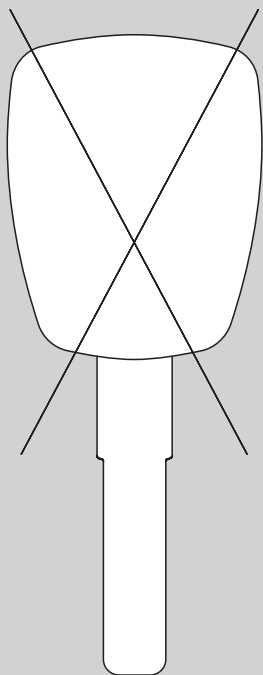

ORIGINAL			DR1 DR2 DR3 DR5	'10 → '10 → '07 → '07 →	 LS7 + TX4 TECH LS8

EAGLE

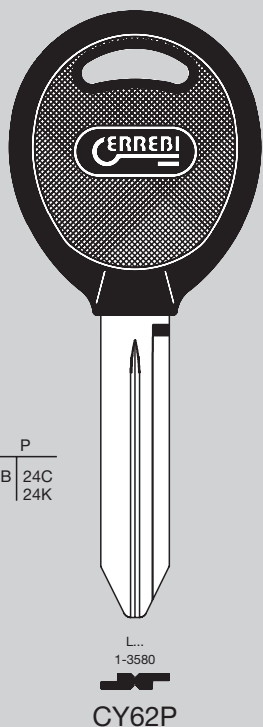

P
B 24C
24K

L...
1-3580

CY62P

(T06)	CY62P	←	VISION	98 →	
(TX2)	CY62P	←			 LS7 + TPX LS8

CHRYSLER

FERRARI

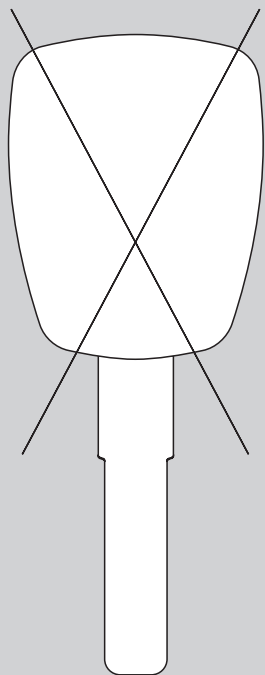

ORIGINAL			458 Italia	'09 →	
			599 Fiorano	'04 →	
			612 Scaglietti	'06 →	
			CALIFORNIA	'08 →	
			F430	'04 →	

FIAT

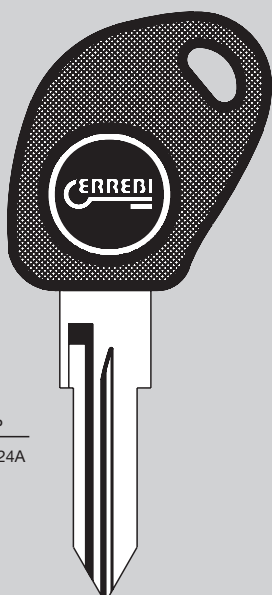

P
B I 24A

N....6001-7000
J....3001-6732
V...1-3051
V...5001-8058
AB....6001-6891

GB9RP

GIOBERT-TRW-SIPEA





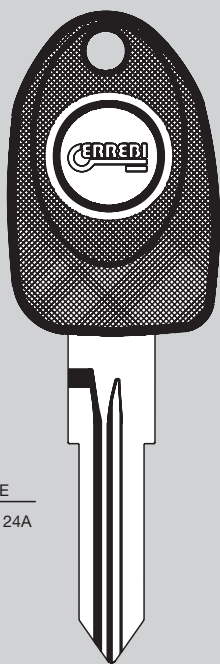



T02	GB9RP	←	CINQUECENTO	'95 → '97	
T05			DUCATO	'96 → '02	
			FIORINO	'96 →	
			PANDA	'95 → '02	
T01	GB9RP	←	CROMA	'95 → '00	
T05					

FIAT



E
B | 24AW...
1-9640

GB14RPE

GIOBERT-TRW-SIPEA

					
T02	GB14RPE	←	BRAVA	'95 → '97	
T05			BRAVO	'95 → '97	
			COUPÈ	'97 → '00	
			PUNTO	'95 → '99	

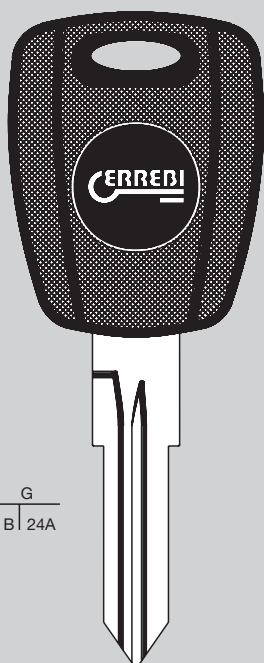
FIAT

G
B | 24AW...
1-9640

GB14RPG

GIOBERT-TRW-SIPEA

					
T01	GB14RPG	←	BARCETTA	'95 →	
T05			BRAVA	'97 →	
			BRAVO	'97 → '00	
			CINQUECENTO	'97 → '00	
			PALIO	'98 →	
			SEICENTO	'97 → '00	

FIAT



D
B | 24A

W....
1-9640

GB14RPD

GIOBERT-TRW-SIPEA

T02	GB14RPD	←	MAREA	'96 →	
T05			MARENGO PUNTO	'96 → '99 → '03	

FIAT



P
B | 24A

W....
1-9640

GB14RP

GIOBERT-TRW-SIPEA

T02	GB14RP	←	TEMPRA	'95 →	
T05					

FIAT



P
B 24L
23B

GB18P

GIOBERT-TRW-SIPEA

ORIGINAL		T00GB18P	DAILY DOBLÒ DUCATO MULTIPLA PUNTO SEICENTO STILO	'00 → '00 → '05 '02 → '05 '98 → '03 → '00 → '01 →	
TX4	GB18P	←	500 BRAVO DOBLÒ DUCATO FIORINO GRANDE PUNTO IDEA PANDA PUNTO EVO QUBO	'07 → '07 → '06 → '06 → '07 → '06 → '03 → '03 → '09 → '08 →	 LS7 + TX4 TECH LS8

FIAT



P
N 24B
24L

111111-628888

SM7P

SIMPLEX

T01 T05	SM7P	←	SCUDO ULYSSE	'95 → '02 '95 → '01	
TX4	SM7P	←	SCUDO	'02 → '06	 LS7 + TX4 TECH LS8

FIAT



P
N | 24L

HF63P

HUF

TX4	HF63P	←	SCUDO ULYSSE	'07 → '02 →	 LS7 + TX4 TECH LS8

FIAT



P
B | 24L

SZ15P

SUZUKI

TX4	SZ15P	←	SEDICI	'06 →	 LS7 + TX4 TECH LS8

FIAT

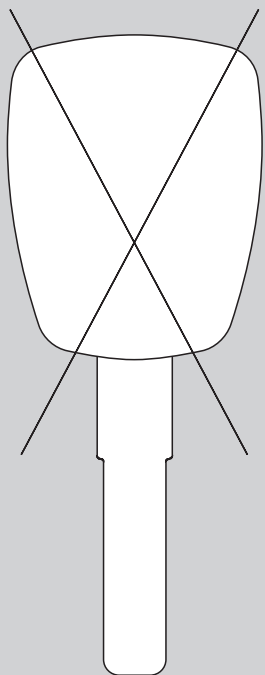

ORIGINAL			CROMA FREEMONT	'05 → '11 →	

FORD

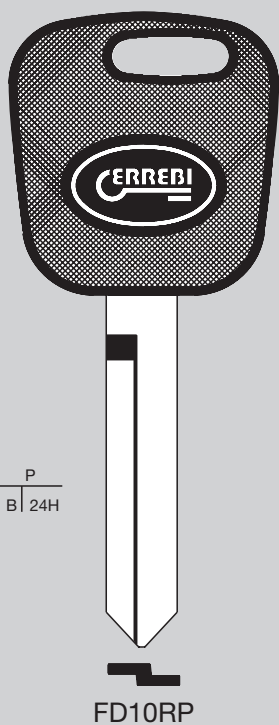

P
B | 24H

FD10RP

STRATTEC

TX1	FD10RP	←	CONTOUR MUSTANG	'98 → '96 → '98	 LS7 LS8

FORD

P
B | 24H

...X
1-1706

FD16RP

STRATTEC

TX1	FD16RP	←	COBRA CROWN VICTORIA EXCURSION EXPEDITION EXPLORER F150 F250 LTD MUSTANG RANGER TAURUS VICTORIA WINDSTAR	'97 → '98 →'02 '00 → '97 →'02 '98 →'01 '99 → '99 →'01 '98 → '98 →'04 '99 → '96 →'00 '98 → '96 →'98	 LS7 LS8

FORD

P
B | 24C
| 24K

...X
1-1706

FD16RP

STRATTEC

T06	FD16RP	←	ESCAPE F250	'01 → '02 →	
TX2	FD16RP	←	FOCUS TRIBUTE	'00 →'05 '01 →	 LS7 + TPX LS8

FORD

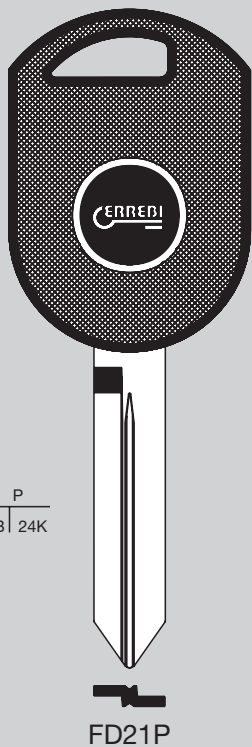

P
B | 24K

FD21P

STRATTEC

TX2	FD21P	←	CROWN VICTORIA EDGE ESCAPE EXPEDITION EXPLORER FIVE HUNDRED FOCUS FREESTAR FREESTYLE F-SERIES	'03 →'10 '07 →'10 '05 →'10 '03 →'10 '02 →'10 '05 →'07 '06 →'10 '04 → '05 → '04 →'10	 LS7 + TPX LS8

FORD

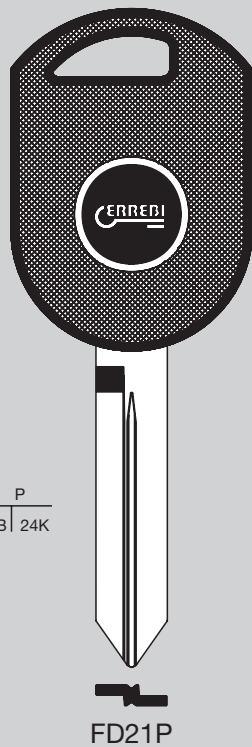

P
B | 24K

FD21P

STRATTEC

TX2	FD21P	←	FUSION HYBRID ESCAPE MUSTANG RANGER TAURUS THUNDERBIRD WINDSTAR	'06 →'10 '05 → '05 →'10 '01 →'10 '00 →'10 '02 →'05 '01 →'04	 LS7 + TPX LS8

FORD

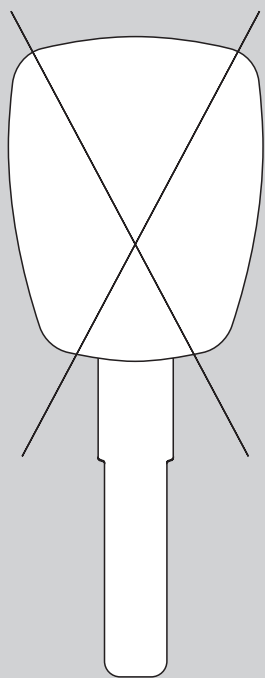

ORIGINAL			CROWN VICTORIA	'11 →	
			EDGE	'11 →	
			ESCAPE	'11 →	
			EXPEDITION	'11 →	
			EXPLORER	'11 →	
			FIESTA	'11 →	
			F-SERIES	'11 →	
			FUSION	'11 →	
			MUSTANG	'11 →	
			RANGER	'11 →	
		TAURUS	'11 →		

FORD (ARG-BRA)

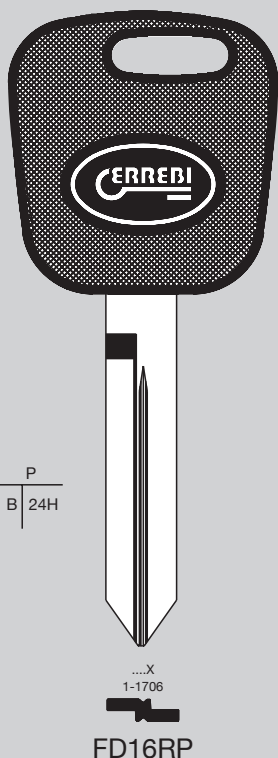

TX2	FD16RP	←	RANGER	'04 →	 LS7 + TPX LS8

FORD (ARG-BRA)



P
N | 24K

HF65P

HUF

TX2	HF65P	←	MONDEO	'07 →	 LS7 + TPX LS8

FORD (ARG-BRA)



P
B | 24K

AK/TC... 1-1000
DM...300-400



KL5P

KOLB

TX2	KL5P	←	ECO SPORT FIESTA FOCUS C-MAX	'03 → '03 → '04 →	 LS7 + TPX LS8

FORD (ARG-BRA)



P
N | 24K

T...
1 AL 4
1-1050



TB1P

TIBBE

TX2	TB1P	←	FOCUS KA MONDEO	'98 → '07 '08 → '06 → '07	 LS7 + TPX LS8

FORD (AUS)



P
B | 24H
24C
24K

...X
1-1706

FD16RP

STRATTEC

TX1	FD16RP	←	B-SERIES EXPLORER TAURUS	'99 → '01 '98 → '02 '96 → '00	 LS7 LS8
T06	FD16RP	←	ESCAPE EXPLORER FOCUS TAURUS TRIBUTE	'01 → '03 → '00 → '00 → '01 →	
TX2	FD16RP	←			 LS7 + TPX LS8

FORD (AUS)



P
N 24K

HF65P

HUF

T33	HF65P	←	FALCON BF TERRITORY	'05 → '05 →	

FORD (AUS)



P
N 24C
24K

T...
1 AL 4
1-1050

TB1P

TIBBE

T06	TB1P	←	FALCON BA TERRITORY	'02 → '05	
TX2	TB1P	←	FALCON BA TERRITORY	'04 → '05	

FORD (AUS)

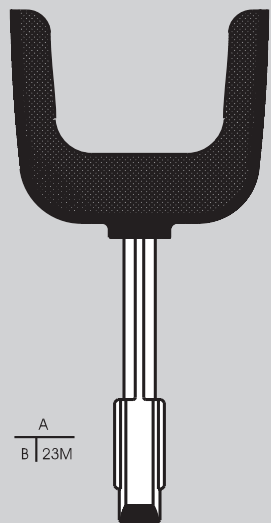

A
B | 23M

T...
1 AL 4
001-1050



TB1PA

TIBBE

ORIGINAL		T00TB1PA	121 FALCON BA TERRITORY	'96 → '02 → '04 →'05	

FORD (UE)

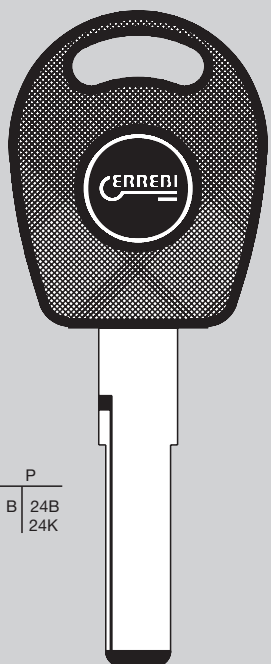

P
B | 24B
24K

AH....
1-8154
1001-9282



HF55P

HUF

T01 T05	HF55P	←	GALAXY	'95 → '97	
TX3	HF55P		GALAXY	'98 → '06	 LS7 + TPX LS8

FORD (UE)

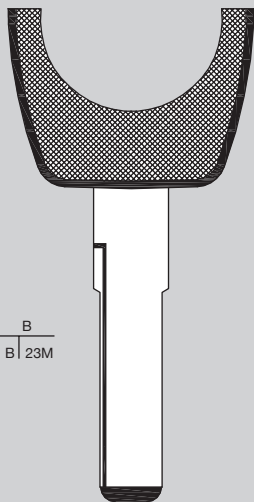

B
B | 23M

HF55PB

HUF

ORIGINAL		T00HF55PB	GALAXY	'98 →	

FORD (UE)

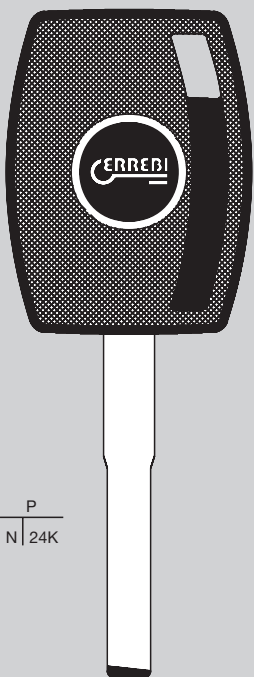

P
N | 24K

HF65P

HUF

TX2	HF65P	←	C-MAX FIESTA FOCUS GALAXY KUGA MONDEO S-MAX	'03 → '08 → '05 →'10 '06 →'10 '08 → '07 →'10 '06 →'10	 LS7 + TPX LS8

FORD (UE)

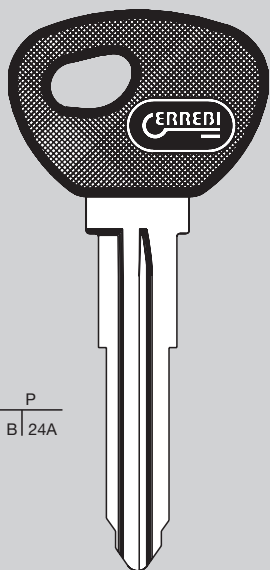

P
B | 24A

10100-12099

MZ12RP

MAZDA

T02	MZ12RP	←	PROBE	'96 →	
T05					

FORD (UE)

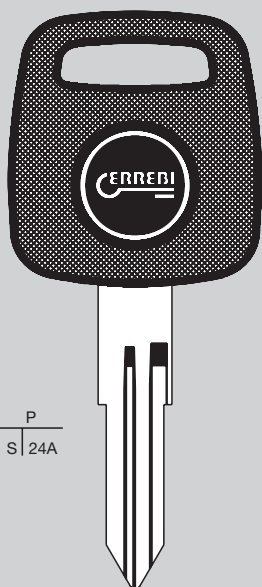

P
S | 24A

X...
1-9000

NS5P

NISSAN

T01	NS5P	←	MAVERICK	'95 →	
T05					

FORD (UE)



P
N | 24H

T...
1 AL 4
1-1050

TB1P

TIBBE

TX1	TB1P	←	COUGAR COURIER K. ESCORT FIESTA KA MONDEO PUMA SCORPIO TRANSIT	'97 → '98 '98 → '95 → '95 → '01 '96 → '01 '95 → '00 '98 → '95 → '95 → '99	 LS7 LS8

FORD (UE)



P
N | 24C
24K

T...
1 AL 4
1-1050

TB1P

TIBBE

T06	TB1P	←	FIESTA FOCUS MONDEO TRANSIT	'01 → '02 '98 → '05 '01 → '00 →	 LS7 + TPX LS8
TX2	TB1P	←	CONNECT FIESTA FOCUS FUSION KA MONDEO TRANSIT	'02 → '01 → '08 '98 → '05 '02 → '02 → '08 '01 → '07 '00 →	 LS7 + TPX LS8

FORD (UE)

A
B | 23M



T...
1 AL 4
001-1050



TB1PA

TIBBE



ORIGINAL

T00TB1PA

CONNECT
COUGAR
COURIER
ESCORT
FIESTA
FOCUS

'02 →
'97 → '98
'98 →
'95 →
'95 → '08
'98 → '05

**FORD** (UE)

A
B | 23M



T...
1 AL 4
001-1050



TB1PA

TIBBE



ORIGINAL

T00TB1PA

FUSION
KA
MONDEO
PUMA
SCORPIO
TRANSIT

'02 →
'96 → '02
'95 → '07
'98 →
'95 → '98
'95 → '97



FORD (UE)

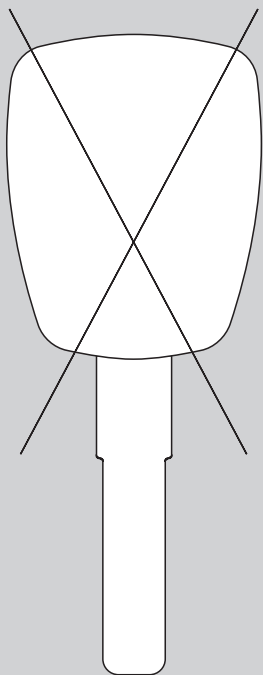

ORIGINAL			FIESTA FOCUS KUGA MONDEO	'08 → '11 → '08 → '11 →	

FREIGHTLINER

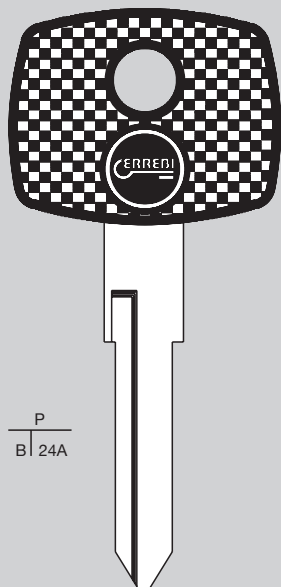

P
B | 24A

HM...1-1200
2501-3500
4001-5795
5801-7350
NF...1-1200
...NF...
01-99/01/99

YMNFP

STRATTEC

T05 T02 - TEMIC -	YMNFP	←	SPRINTER	'02 →	

GMC



P
B | 24L

GM36P

G.M.

TX4	GM36P	←	ACADIA DENALI ENVOY SAVANA SIERRA YUKON	'07 → '07 → '07 → '07 → '07 → '07 →	 LS7 + TX4 TECH LS8

GMC



B
N | 24L

HF66PB

HUF

TX4	HF66PB	←	TERRAIN	'10 →	 LS7 + TX4 TECH LS8

GMC

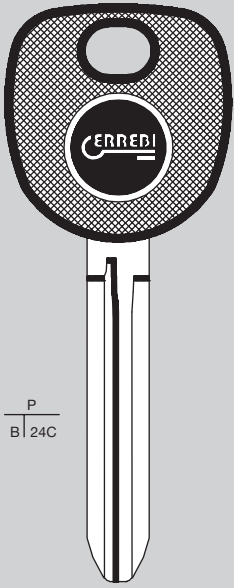

P
B | 24C



TY37PA

TOYOTA

T08	TY37PA	←	CANYON	'08 →	<p>TRACK 7</p>

GREAT WALL MOTOR

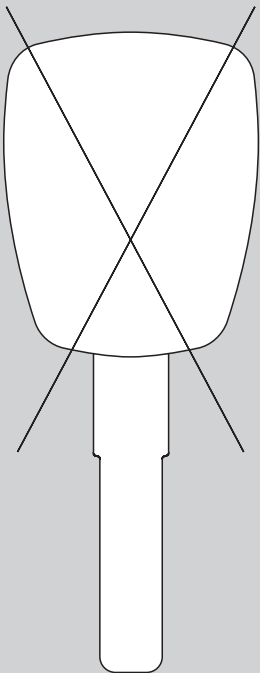

ORIGINAL

			HOVER PEGASUS SPEED WINGLE	'06 → '07 → '08 → '07 →	<p>CAR CONCESSIONARY</p>

HOLDEN



P
B | 24A



N....
5001-7000

GM10P

G.M.

T01	GM10P	←	FRONTERA	'96 → '99	
T05					

HOLDEN



P
B | 24L



GM37P

G.M.

TX4	GM37P	←	COMMODORE	'06 →	 LS7 + TPX LS8

HOLDEN



P
B | 24B
24D

H...
WH...
1-3000

Y...
WY...
1-3000

HF42P

YM22P

HUF-YMOS

T01	HF42P	←	VECTRA	'95 → '98	
T05	YM22P				
T09	HF42P	←	VECTRA	'98 → '01	 TRACK 7

HOLDEN

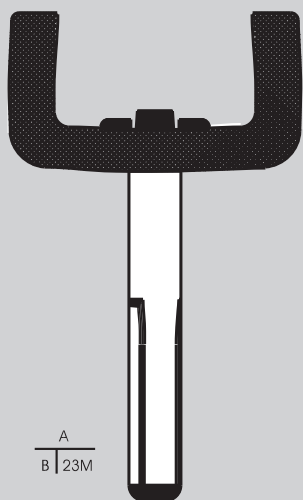

A
B | 23M

H...
WH...
1-3000

HF42PA

HUF

ORIGINAL		T00HF42PA	VECTRA	'98 → '04	

HOLDEN



P
S 24A
24D



HF43P



YM24P

HUF-YMOS

T01 T05	HF43P	←	ASTRA BARINA COMBO	'95 → '98 '95 → '98 '95 → '98	
T01 T05	YM24P	←	ASTRA BARINA	'95 → '98 '95 → '98	
T09	HF43P	←	ASTRA BARINA COMBO	'98 → '98 → '98 →	 TRACK 7

HOLDEN

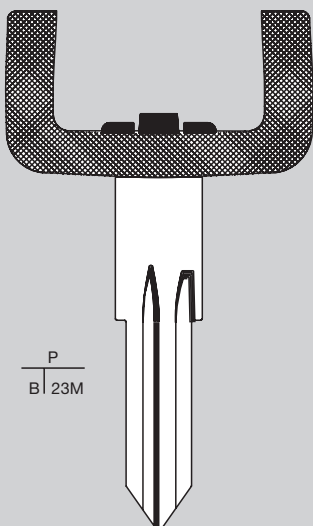

P
B 23M



HF43PA



YM24P

HUF-YMOS

ORIGINAL		T00HF43PA	ASTRA BARINA	'98 → '04 '98 → '06	
		T00YM24PA	ASTRA BARINA	'98 → '04 '98 → '06	

HOLDEN

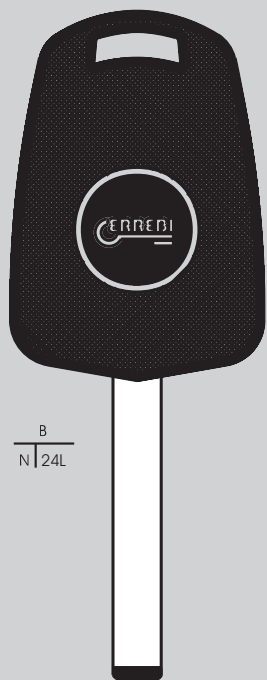

B
N | 24L

HF66PB

HUF

TX4	HF66PB	←	ASTRA VECTRA ZAFIRA	'04 → '04 → '04 →	 LS7 + TX4 TECH LS8

HOLDEN

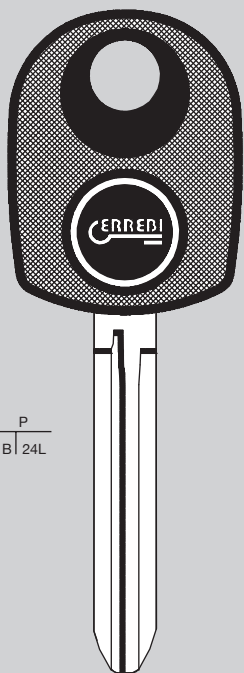

P
B | 24L

TY37P

TX4	TY37P	←	COMMODORE	'06 →	 LS7 + TX4 TECH LS8

HOLDEN

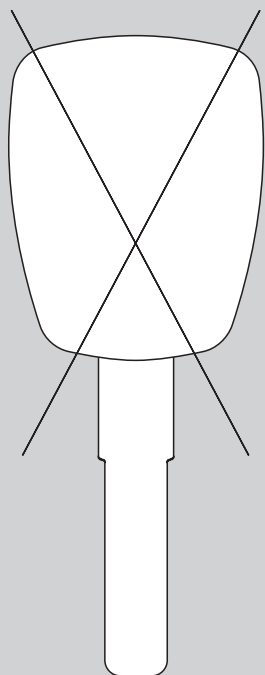

ORIGINAL			FRONTERA JACKAROO VIVA	'99 → '99 → '06 →	

HONDA

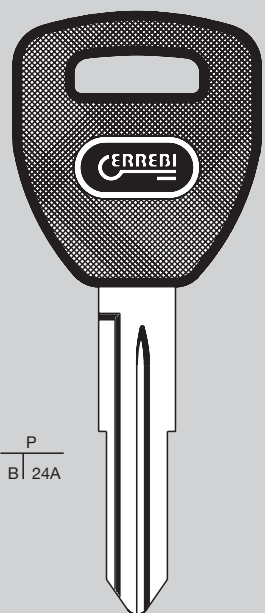

P
B | 24A

...5001-8442

HD43RP

T02 T05	HD43RP	←	ACCORD AERO ACCORD COUPÈ CIVIC CR-V INTEGRA LEGEND PASSPORT PRELUDE SHUTTLE	'95 → '95 → '95 → '01 '95 → '00 '99 → '97 → '06 '98 → '97 → '95 → '00	

HONDA

HONDA

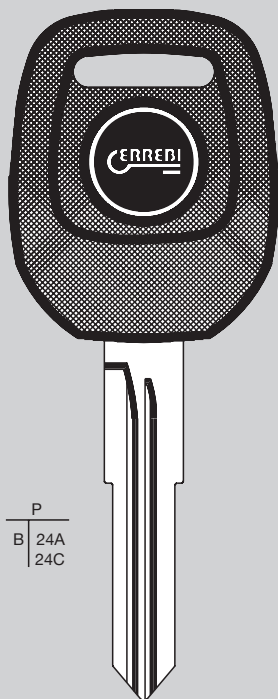









P
B | 24A
24C

R...
6001-8000

NE80P

NEIMAN

					
T01 T05	NE80P	←	ACCORD CIVIC	'95 → '98 '95 → '01	
T08	NE80P	←	ACCORD HR-V LOGO SHUTTLE	'98 → '06 '00 → '99 → '00 →	 TRACK 7

HONDA

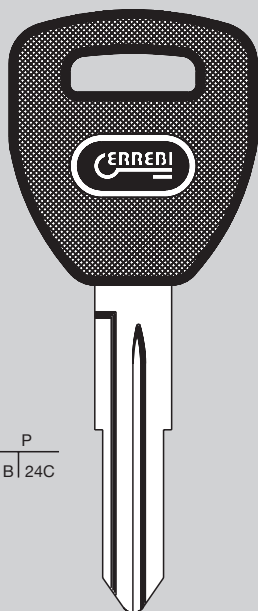







P
B | 24C

...5001-8442

HD43RP

HONDA

					
T08	HD43RP	←	ACCORD CIVIC CR-V HR-V INSIGHT S-2000 STREAM	'03 → '06 '01 → '02 '00 → '03 '00 → '01 → '05 '00 → '03 '01 → '03	 TRACK 7

HONDA

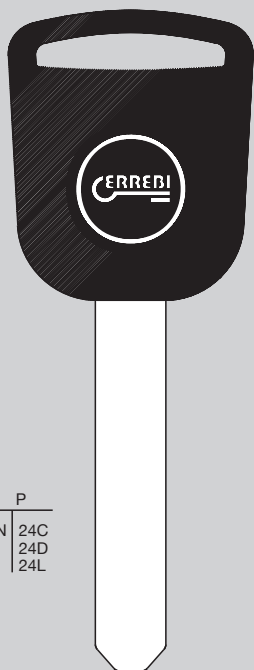

P
N 24C
24D
24L

...
K001-N718

HD58P

HONDA

T08	HD58P	←	CIVIC CR-V FR-V JAZZ S-2000 STREAM	'02 → '05 '03 → '06 '04 → '07 '02 → '06 '04 → '05 '03 → '07	 TRACK 7
T32	HD58P	←	ACCORD FR-V JAZZ LEGEND S-2000	'06 → '08 '07 → '06 → '07 → '06 →	 CAR CONCESSIONARY
TX4	HD58P	←	ACCORD CIVIC CR-V CR-Z INSIGHT JAZZ STREAM	'03 → '06 → '07 → '10 → '09 → '09 → '08 →	 LS7 + TX4 TECH LS8

HONDA (USA)

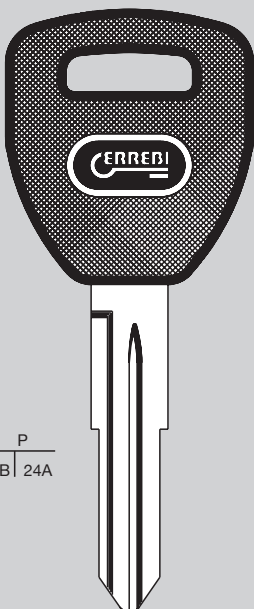

P
B 24A

...5001-8442

HD43RP

HONDA

T02 T05	HD43RP	←	ACCORD CIVIC INSIGHT ODYSSEY PRELUDE S 2000	'98 → '02 '01 → '02 '00 → '06 '98 → '02 '97 → '02 '00 → '03	

HONDA (USA)

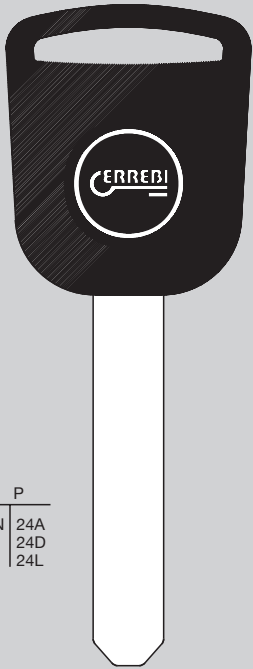

P
N 24A
24D
24L

...
K001-N718

HD58P

HONDA

T05	HD58P	←	CR-V ELEMENT ODISSEY PILOT	'02 → '06 '03 → '05 '03 → '04 '03 → '05	
TX4	HD58P	←	ACCORD CIVIC CR-V ELEMENT FIT ODYSSEY PILOT RIDGELINE	'03 → '06 → '07 → '06 → '09 → '05 → '06 → '05 →	 LS7 + TX4 TECH LS8
T32	HD58P	←	FIT S-2000	'07 → '08 '06 →	

HUMMER

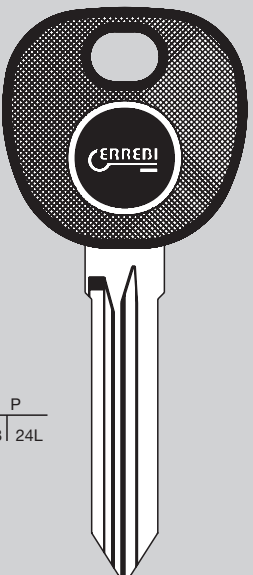

P
BI 24L

GM36P

TX4	GM36P	←	H2 H2 SUT	'08 → '08 →	 LS7 + TX4 TECH LS8

HUMMER

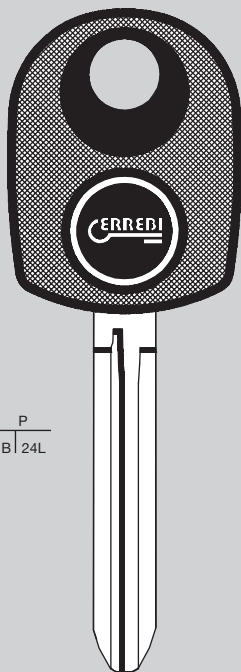

P
B | 24L



TY37P

TOYOTA

T08	TY37P	←	H3	'08 →	 TRACK 7

HUMMER

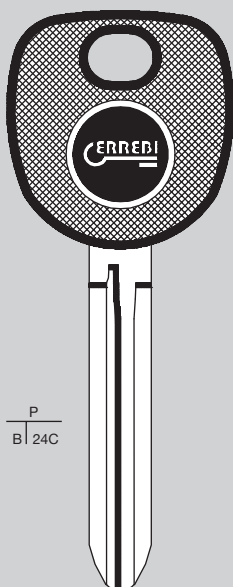

P
B | 24C



TY37PA

TOYOTA

T08	TY37PA	←	H3	'08 →	 TRACK 7

HYUNDAI



P
B | 24H

R...
1-1000

HYN6P

HYUNDAI

TX1	HYN6P	←	ACCENT ATOS ATOS PRIME EXCEL PONY VERNA	'96 → '99 '98 → '00 '00 → '02 '96 → '99 '95 → '99 '96 → '99	 LS7 LS8

HYUNDAI



P
B | 24H
24K

T...
1-1000

HYN1P

HYUNDAI

TX1	HYN1P	←	COUPÈ GALLOPER H1 INNOVATION LANTRA S-COUPÈ SANTAMO	'96 → '02 '99 → '99 → '06 '99 → '03 '96 → '96 → '00 →	 LS7 LS8
TX2	HYN1P	←	ELANTRA	'00 → '06	 LS7 + TPX LS8

HYUNDAI



P
B | 24L

T...
1-1000

HYN1P

HYUNDAI

TX4	HYN1P	←	ACCENT COUPÈ ELANTRA EXCEL GETZ H1 LAVITA MATRIX SANTA FÈ TERRACAN TIBURON TUCSON VERNA	'00 → '02 → '01 →'06 '99 → '02 →'09 '06 → '01 → '02 → '02 →'06 '01 →'07 '01 → '05 → '99 →	 LS7 + TX4 TECH LS8

HYUNDAI



P
B | 24H
24K

S....
1-1000

HYN4RP

HYUNDAI

TX1	HYN4RP	←	SONATA SONICA	'96 →'98 '96 →'99	 LS7 LS8
TX2	HYN4RP	←	GRANDEUR XG SANTA FÈ SONATA SONICA TRAJET XG 25 XG 30	'98 → '00 →'02 '98 →'04 '99 → '00 → '98 → '98 →	 LS7 + TPX LS8

HYUNDAI

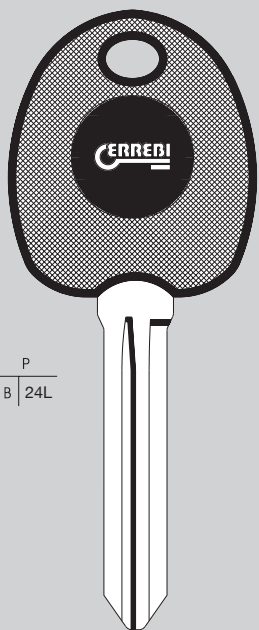

P
B | 24L

KIA4P

KIA

TX4	KIA4P	←	ENTOURAGE H1 I10	'07 → '08 → '08 →	 LS7 + TX4 TECH LS8

HYUNDAI

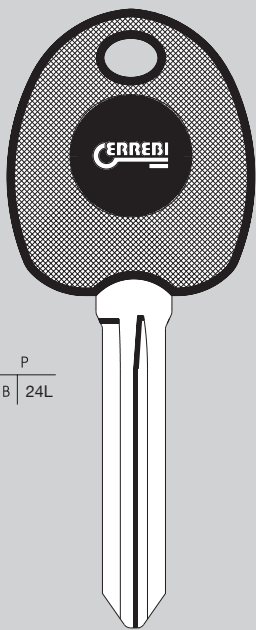

P
B | 24L

KIA4RP

KIA

TX4	KIA4RP	←	ELANTRA SANTA FÈ SONATA VERACRUZ	'07 → '06 → '05 → '09 →	 LS7 + TX4 TECH LS8

HYUNDAI



P
B | 24L



KIA7P

KIA

TX4	KIA7P	←	AZERA ELANTRA NEOS GENESIS GRANDEUR I20 I30 I40 I45 IX20 IX35	'06 → '07 → '09 → '06 → '08 → '07 → '10 → '09 → '10 → '10 →	 LS7 + TX4 TECH LS8

HYUNDAI



P
B | 24H



A...
1-1000
HYN12P

HYUNDAI

TX1	HYN12P	←	STAREX	'98 →	 LS7 LS8

HYUNDAI

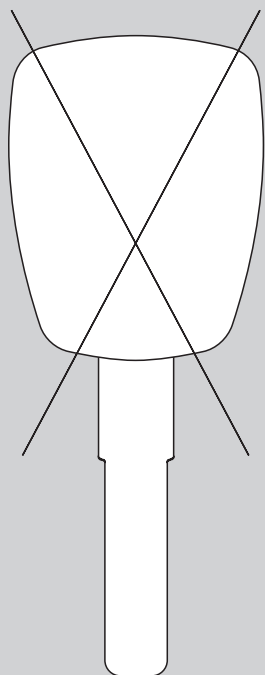

ORIGINAL			ATOS EQUUS H-100	'00 → '11 → '01 →	

HYUNDAI (USA)

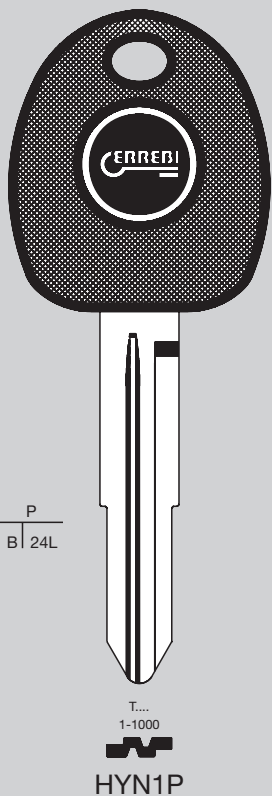

TX4	HYN1P		ACCENT TIBURON	'08 → '10 '03 → '08	

HYUNDAI

HYUNDAI (USA)



P
B | 24K

S...
1-1000

HYN4RP

HYUNDAI

TX2	HYN4RP	←	XG 300 XG 350	'01 → '01 →	 LS7 + TPX LS8

HYUNDAI (USA)

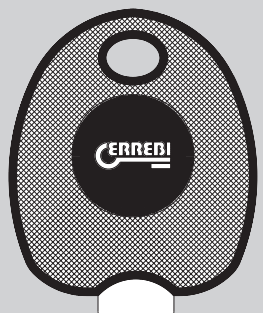

P
B | 24L

KIA4RP

KIA

TX4	KIA4RP	←	ELANTRA ENTOURAGE GENESIS SANTA FÈ SONATA TUCSON VERACRUZ	'09 → '11 '06 → '09 '10 → '07 → '07 → '10 → '07 →	 LS7 + TX4 TECH LS8

INFINITI



P
B | 24K

X...
1-9000
NS5P

NISSAN

TX3	NS5P	←	I 30	'99 → '00	 LS7 LS8

INFINITI



P
B | 24H
24K
24L

.....
1-22185
NS8P

NISSAN

TX1	NS8P	←	Q45	'97 → '01	 LS7 LS8
TX2	NS8P	←	G20 I 30 I 35 Q45 QX4	'00 → '02 '00 → '04 '00 → '04 '02 → '99 → '04	 LS7 + TPX LS8
TX4	NS8P	←	FX 35 FX 45 G 35 QX 56	'03 → '08 '03 → '08 '03 → '07 '04 → '07	 LS7 + TX4 TECH LS8

INFINITI

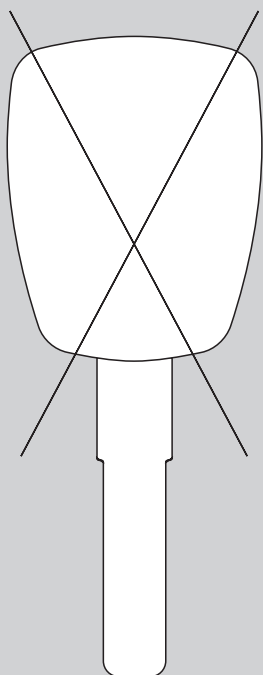

ORIGINAL			EX35	'00 → '09	
			FX35	'09 →	
			FX50	'09 →	
			G25	'11 →	
			G37	'08 →	
			M35	'06 → '10	
			M37	'11 →	
			M45	'03 →	
			M56	'11 →	
			Q45	'02 → '06	
		QX56	'08 →		

ISUZU

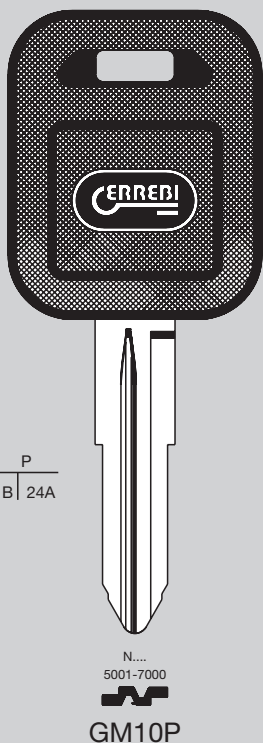

T01	GM10P	←	TROOPER	'96 → '99	
T05					

ISUZU



A
B | 24C

...5001-8442

HD43RP

HONDA

T08	HD43RP	←	AXIOM RODEO	'03 → '06 →	 TRACK 7

ISUZU



P
B | 24K

U...
1-2000

SZ11P

SUZUKI





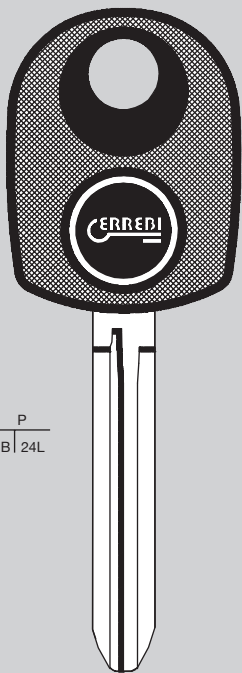

TX2	SZ11P	←	BIG HORN TROOPER	'98 → '98 →	 LS7 + TPX LS8

ISUZU



P
B | 24L







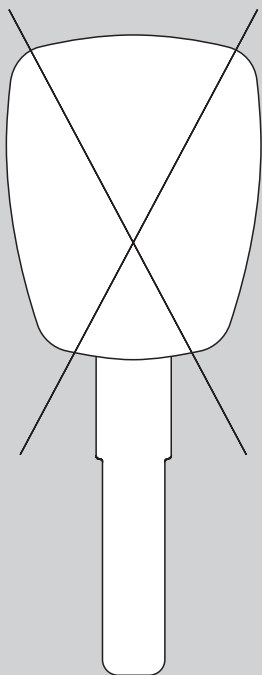

TY37P

					
TX4	TY37P	←	D-MAX	'07 →	 LS7 + TX4 TECH LS8

ISUZU



ORIGINAL

					
			ASCENDER I-290 I-370	'07 → '07 → '07 →	

JAGUAR



P
N | 24K



T...
1 AL 4
1-1050



TB1P

TIBBE

T06	TB1P	←	S-TYPE	'99 → '00	
TX2	TB1P	←	XJ X-TYPE	'03 → '07 '00 → '08	 LS7 + TPX LS8

JAGUAR



P
N | 24B

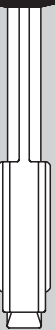

T...
1-2330



TB2P

TIBBE

T02	TB2P	←	SOVEREIGN	'96 →	
T05			XJ	'98 → '00	
			XJS	'98 →	
			XK8	'98 →	

JAGUAR

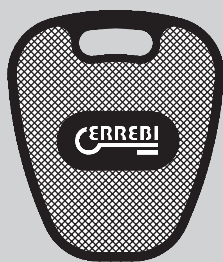

P
NI 24L

TB4P

TIBBE

TX4	TB4P	←	S-TYPE	'99 → '00	 LS7 + TX4 TECH LS8

JAGUAR

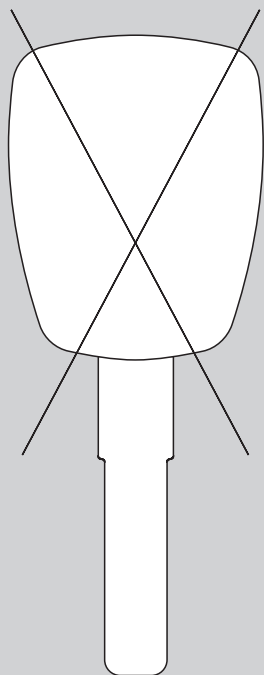

ORIGINAL

			XJ XK	'00 → '00 →	

JEEP

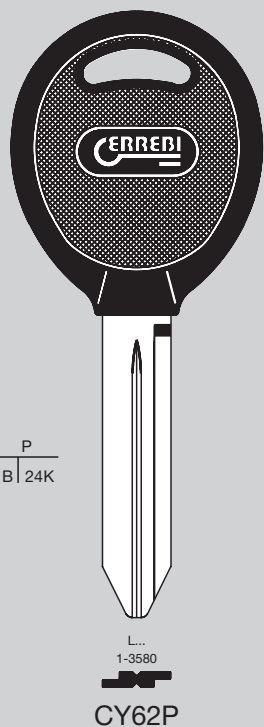

P
B | 24K

L...
1-3580
CY62P

CHRYSLER

TX2	CY62P	←	CHEROKEE GRAND CHEROKEE LIBERTY WRANGLER	'98 → '01 '99 → '05 '01 → '04 '98 → '06	 LS7 + TPX LS8

JEEP

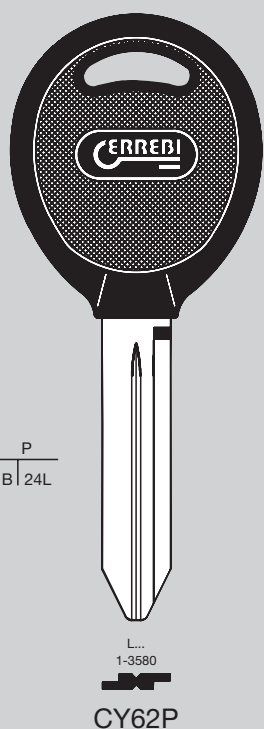

P
B | 24L

L...
1-3580
CY62P

CHRYSLER

TX4	CY62P	←	COMMANDER COMPASS GRAND CHEROKEE LIBERTY PATRIOT WRANGLER	'06 → '07 → '06 → '05 → '07 → '07 →	 LS7 + TX4 TECH LS8

KIA









P
B | 24L

T....
1-1000

HYN1P

HYUNDAI

					
TX4	HYN1P	←	CERATO MORNING PICANTO SPORTAGE	'04 → '09 '06 → '04 → '08 '04 →	 LS7 + TX4 TECH LS8

KIA









P
B | 24L

S....
1-1000

HYN4RP

HYUNDAI

					
TX4	HYN4RP	←	SORENTO	'02 → '06	 LS7 + TX4 TECH LS8

KIA

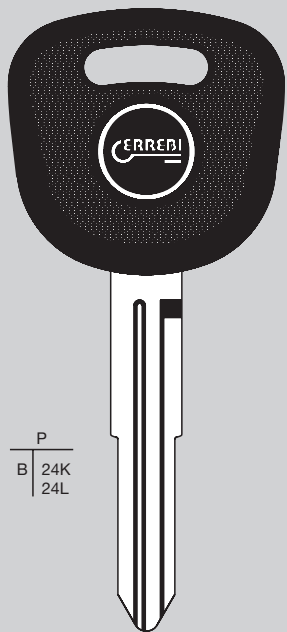

P
B 24K
24L

Y...
2001-3000



KIA3P



KIA3RP

KIA

T02 T05	KIA3P	←	CLARUS	'98 →	
T02 T05	KIA3RP	←	CLARUS PRIDE SHUMA SPORTAGE	'98 → '99 → '98 →'00 '95 →'98	
T08	KIA3RP	←	SPORTAGE	'99 →'01	 TRACK 7

KIA

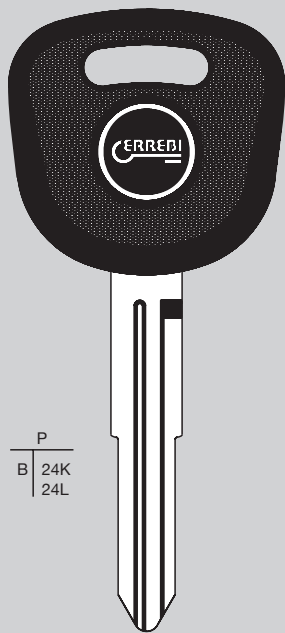

P
B 24K
24L

KIA3RP

KIA

TX2	KIA3RP	←	CARENS CARNIVAL CLARENCE JOICE NEW CARNIVAL RIO SEDONA SEPHIA SHUMA SPORTAGE	'00 →'04 '00 →'02 '01 → '00 → '06 → '01 →'05 '00 →'02 '00 →'02 '00 →'01 '01 →'03	 LS7 + TPX LS8
TX4	KIA3RP	←	CARENS CARNIVAL MAGENTIS MENTOR OPTIMA SEDONA SEPHIA SHUMA	'05 →'06 '02 →'05 '01 →'06 '02 →'04 '01 →'06 '02 →'06 '02 →'04 '02 →	 LS7 + TX4 TECH LS8

KIA

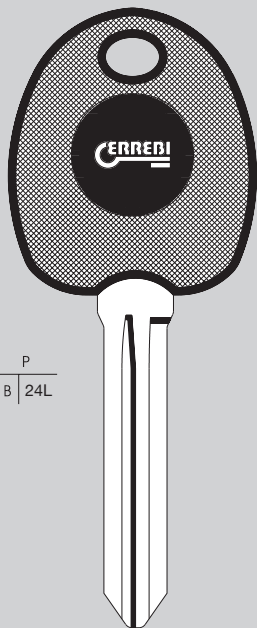

P
B 24L



KIA4P

KIA

TX4	KIA4P	←	CARENS CARNIVAL OPTIMA SEDONA	'06 → '06 → '06 → '06 →	 LS7 + TX4 TECH LS8

KIA

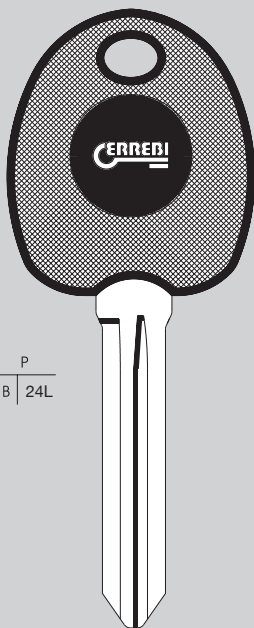

P
B 24L



KIA4RP

KIA

TX4	KIA4RP	←	FORTE MAGENTIS SOUL	'08 → '06 → '09 →	 LS7 + TX4 TECH LS8

KIA

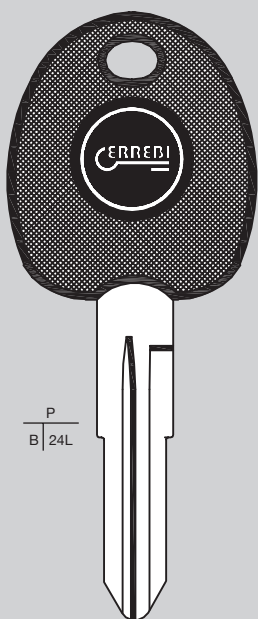

P
B | 24L

WA...
1001-3040

KIA5P

KIA

TX4	KIA5P	←	RIO	'06 →	<p>LS7 + TX4 TECH LS8</p>

KIA

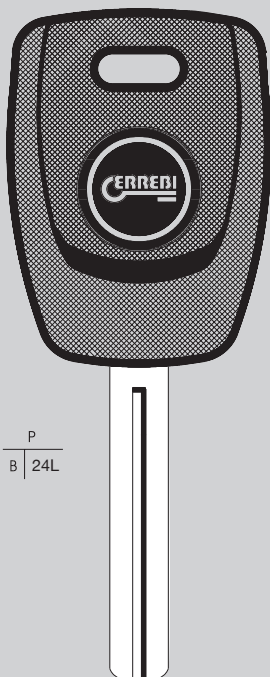

P
B | 24L

KIA7P

KIA

TX4	KIA7P	←	AMANTI CEE'D CEE'D SW PICANTO SORENTO	'07 → '07 → '07 → '08 →'11 '10 →	<p>LS7 + TX4 TECH LS8</p>
TX2	KIA7P	←	AMANTI	'04 →'06	<p>LS7 + TPX LS8</p>

KIA

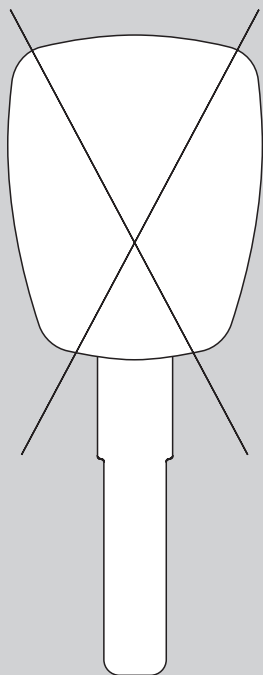

ORIGINAL			OPIRUS PICANTO SPECTRA VENGA	'06 → '11 → '04 → '09 '10 →	

LANCIA

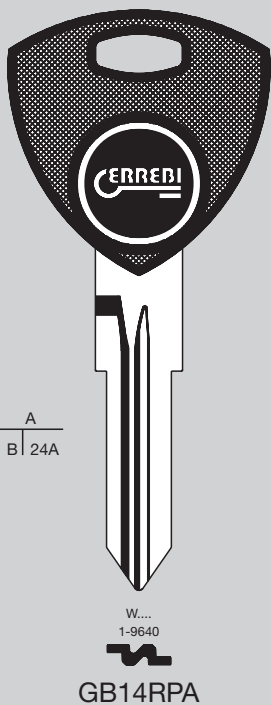

T02 T05	GB14RPA	←	DEDRA DELTA	'95 → '97 '95 →	
T02	GB14RPA	←	DEDRA Y	'97 → '95 →	

LANCIA

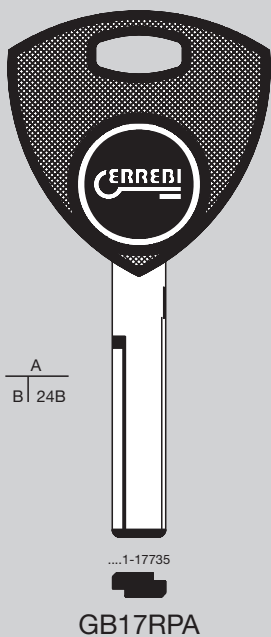

GIOBERT-TRW-SIPEA

T01 T05	GB17RPA	←	K	'95 →	

LANCIA

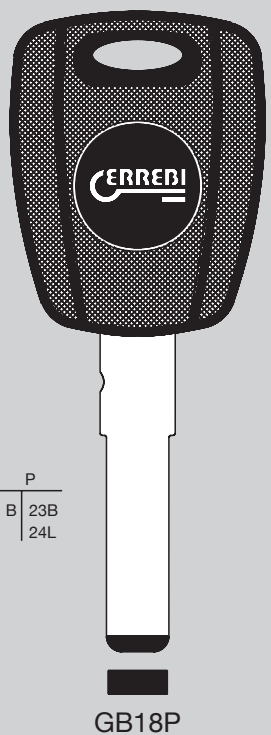

GIOBERT-TRW-SIPEA

ORIGINAL		T00GB18P	LYBRA MUSA THESIS YPSILON	'99 → '04 →'09 '02 → '03 →'11	
TX4	GB18P	←	DELTA MUSA YPSILON	'08 → '09 → '11 →	 LS7 + TX4 TECH LS8

LANCIA

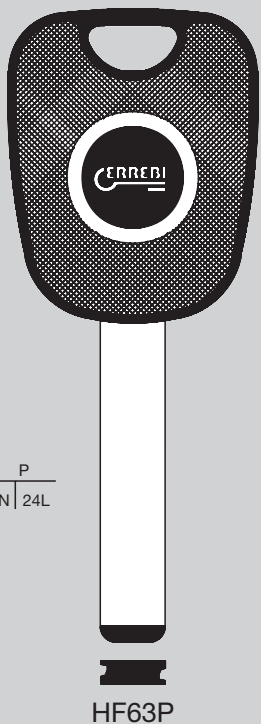

HUF

TX4	HF63P	←	PHEDRA	'02 →	<p>LS7 + TX4 TECH LS8</p>

LANCIA

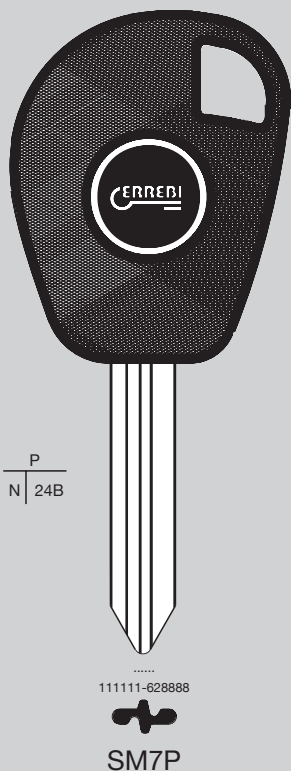

SIMPLEX

T01 T05	SM7P	←	Z2000	'95 →	

LAND ROVER

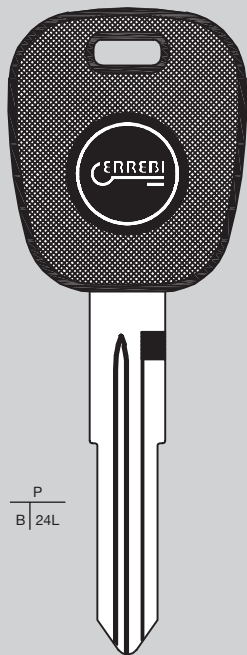

P
B | 24L



NE57P

NEIMAN

TX4	NE57P	←	FREELANDER	'03 →	<p>LS7 + TX4 TECH LS8</p>

LAND ROVER

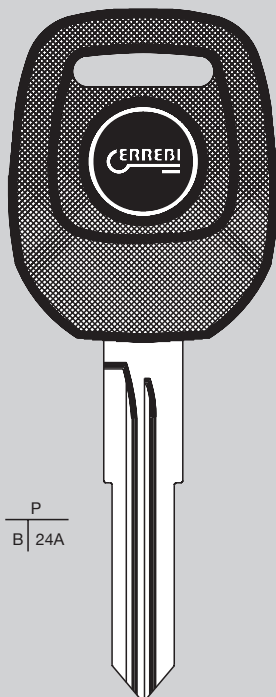

P
B | 24A

R....
6001-6000



NE80P

NEIMAN

T01 T05	NE80P	←	DISCOVERY RANGE ROVER 4.0 RANGE ROVER 4.6	'95 → '98 '95 → '98 '95 → '98	

LAND ROVER

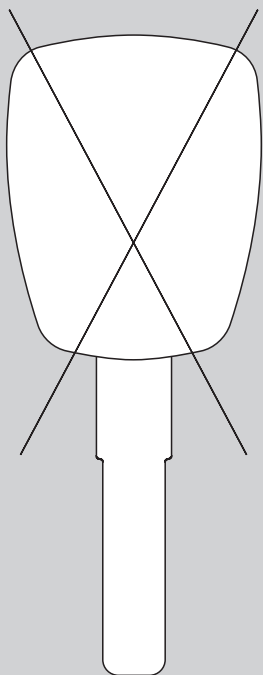

ORIGINAL			DEFENDER	'98 →	
			DISCOVERY 2	'98 → '05	
			DISCOVERY 3	'06 → '09	
			FREELANDER	'98 → '03	
			RANGE ROVER	'99 →	

LEXUS

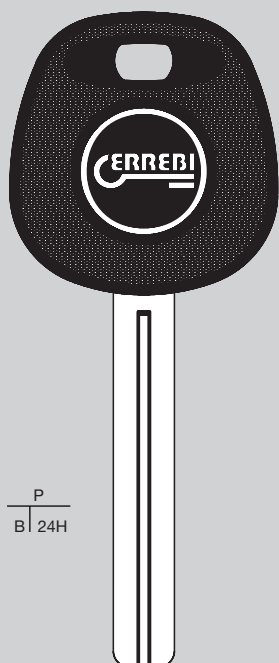

P
B | 24H

1-5000

TY43P

TOYOTA

TX1	TY43P	←	CELSIOR	'97 →	
			ES300	'98 → '01	
			LS400	'97 → '99	
			LS430	'97 → '99	
			LX450	'98 → '99	
			LX470	'99 → '02	
			SC300	'98 →	
			SC400	'98 →	
			SC430	'98 → '02	

LEXUS

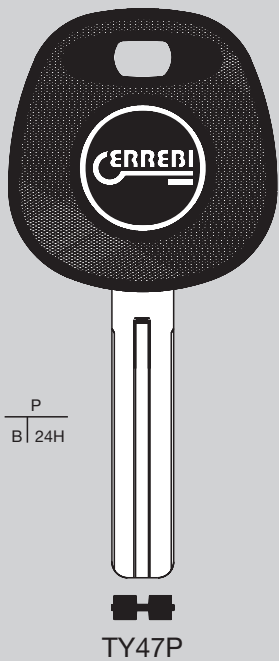

P
B | 24H

TY47P

TOYOTA

TX1	TY47P	←	ALTEZZA ES300 GS300 GS400 GS430 IS200 IS300 LS200/LS400 LS430 LX RX300	'99 → '02 → '03 '98 → '05 '98 → '01 '01 → '05 '99 → '01 → '99 → '99 → '01 '98 → '99 →	 LS7 LS8

LEXUS

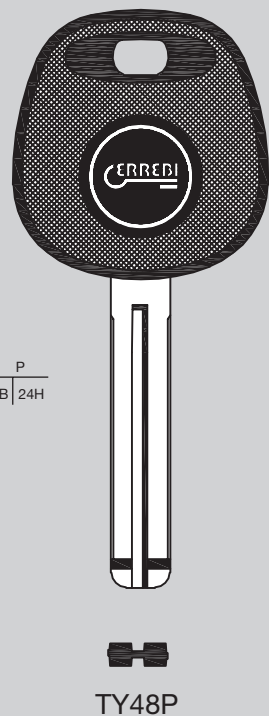

P
B | 24H

TY48P

TOYOTA

TX1	TY48P	←	ALTEZZA ES300 GS300 GS400 IS200 IS300 LS200 LS400 LS430 LX RX300	'99 → '02 → '03 '98 → '98 → '99 → '01 → '99 → '99 → '99 → '01 '98 → '99 →	 LS7 LS8



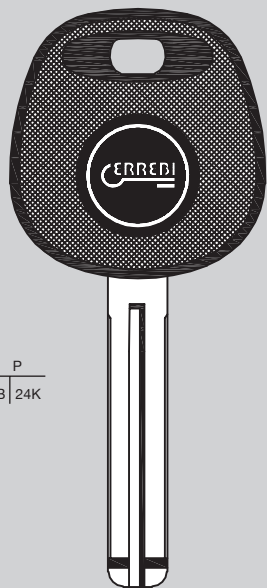



LEXUS



P
B | 24K

TY48P

TOYOTA

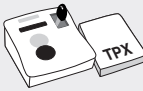
					
TX2	TY48P	←	ES330 ES350 GS300 GS350 GS430 GX470 IS250 IS350 LS430 LX470	'04 → '06 '06 → '05 → '07 → '05 → '07 '03 → '06 '06 → '06 → '01 → '04 '03 → '08	 LS7 + TPX LS8







LEXUS



P
B | 24K

TY48P

TOYOTA

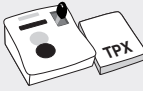
					
TX2	TY48P	←	RX330 RX350 RX400H RX450H SC430	'04 → '09 '04 → '11 '05 → '09 '10 → '02 → '10	 LS7 + TPX LS8

LINCOLN



P
B | 24H

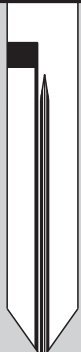

...X
1-1706

FD16RP

STRATTEC

TX1	FD16RP	←	BLACKWOOD CONTINENTAL NAVIGATOR TOWN CAR	'02 → '03 '98 → '02 '97 → '02 '97 → '02	 LS7 LS8
TX2	FD16RP	←	LS	'98 → '02	 LS7 + TPX LS8

LINCOLN



P
B | 24K

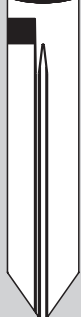

FD21P

STRATTEC

TX2	FD21P	←	AVIATOR LS MARK LT MKS MKX MKZ NAVIGATOR TOWN CAR ZEPHIR	'03 → '06 '02 → '06 '05 → '08 '08 → '09 '07 → '07 → '02 → '10 '02 → '06 → '09	 LS7 + TPX LS8

LINCOLN

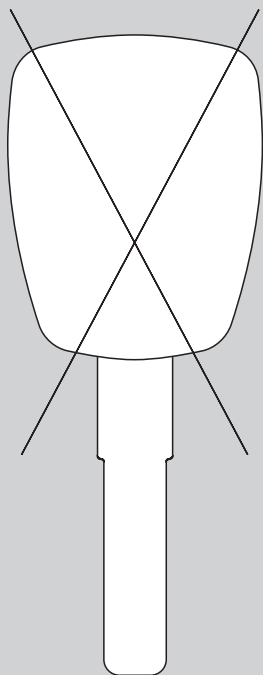

ORIGINAL			MARK LT	'11 →	
			MARK VIII	'97 →	
			MKS	'10 →	
			MKT	'10 →	
			NAVIGATOR	'11 →	

LOTUS

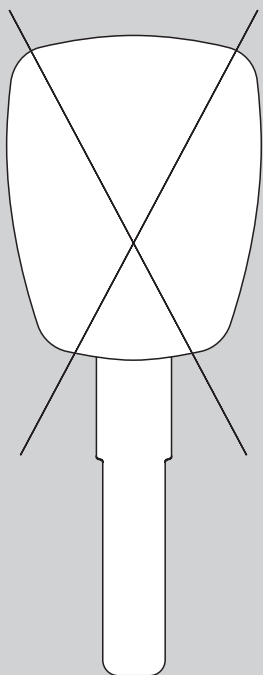

ORIGINAL			ELISE	'04 →	
			EUROPA	'06 →	
			EVORA	'11 →	
			EXIGE	'04 →	

MASERATI

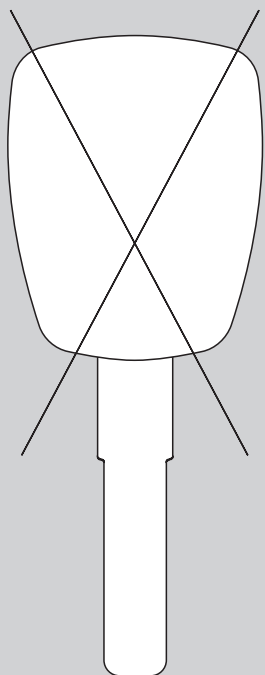

ORIGINAL			COUPÈ GRANSPORT QUATTROPORTE	'02 → '04 → '04 →	

MAYBACH

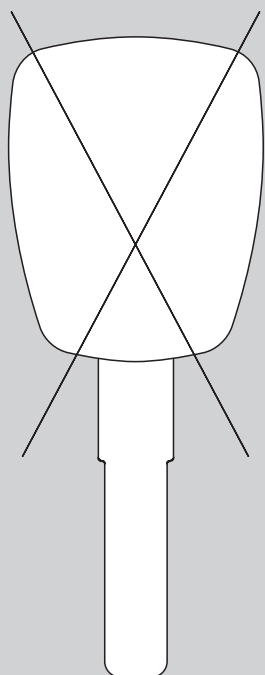

ORIGINAL			57 62	'02 → '02 →	

MAZDA

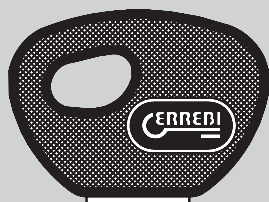

P
B | 24A

10100-12283
MZ19RP

MAZDA

T02	MZ19RP	←	626 MX6 XEDOS 6	'95 → '98 '95 → '95 →	
TEMIC					

MAZDA

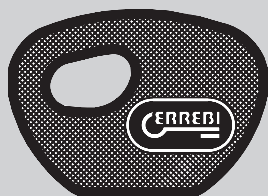

P
B | 24A

10100-12099
MZ12RP

MAZDA

T02	MZ12RP	←	323 MX3 MX5	'95 → '97 '95 → '95 → '98	

MAZDA

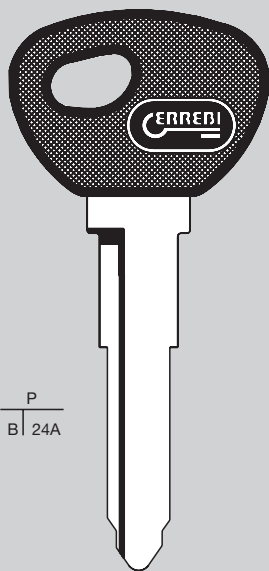

P
B | 24A

10100-12099

MZ23RP

T01	MZ23RP	←	323	'97 → '98		
T05			626 MX5	'98 → '99 '98 → '04		
T02	MZ23RP	←	323	'98 → '99		
TEMIC						

MAZDA

MAZDA

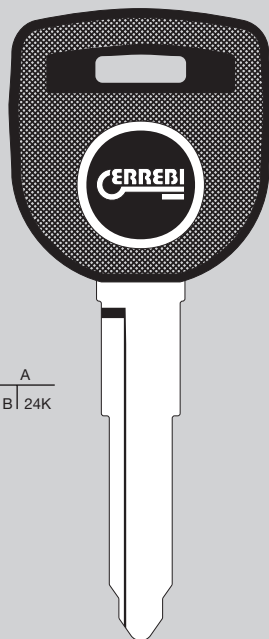

A
B | 24K

MZ23RPA

TX2	MZ23RPA	←	2 3 5 6 CX - 7 CX - 9 MPV MX5 RX8	'03 → '04 → '05 → '03 → '07 → '07 → '04 → '05 → '03 →		
						LS7 + TPX LS8

MAZDA

MAZDA



P
B | 24B



MIT13P

mitsubishi

T02	MIT13P	←	XEDOS 9	'95 →	

MAZDA



P
N | 24H

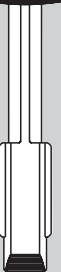

T...
1 AL 4
1-1050



TB1P

tibbe

TX1	TB1P	←	121	'97 →	 LS7 LS8

MAZDA

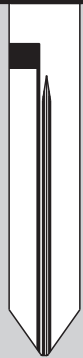

...X
1-1706

FD16RP

P
B 24H
24C
24K

STRATTEC

TX1	FD16RP	←	PICKUPS 3000 PICKUPS 4000	'99 → '01 '99 → '01	 LS7 LS8
T06	FD16RP	←	TRIBUTE	'01 → '07	 LS7 + TPX LS8
TX2	FD16RP	←			

MAZDA



FD21P

P
B 24K

STRATTEC

TX2	FD21P	←	PICKUPS 3000 PICKUPS 4000	'01 → '01 →	 LS7 + TPX LS8

MAZDA

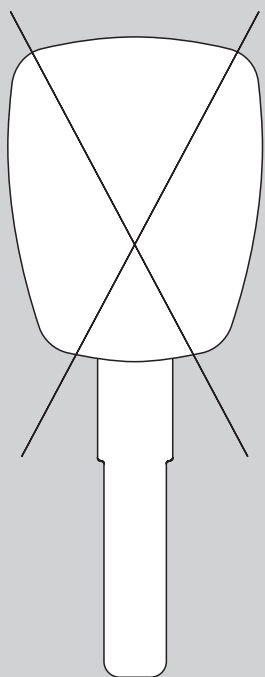

YMOS

ORIGINAL			323	'99 →	
			626	'99 →	
			B3000	'01 →	
			B4000	'01 →	
			BT-50	'07 →	
			DEMIO	'99 →	
			MIATA	'01 →	
			MPV	'00 →	
			PREMACY	'00 →	

MERCEDES

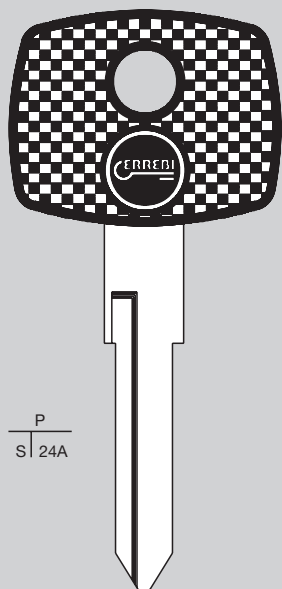

HM...1-1200
2501-3500
4001-5795
5801-7350
NF...1-1200
...NF...
01-99/01/99

YMNFP

T02	YMNFP	←	SPRINTER VITO	'97 → '98 →	
T02 T05	YMNFP		VITO	'98 →	

MERCEDES

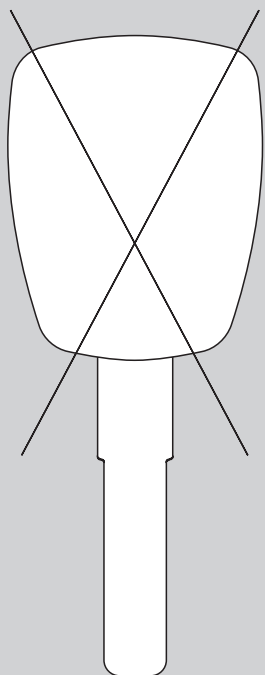

ORIGINAL			Classe A	'98 →	
			Classe B	'05 →	
			Classe C	'95 →	
			Classe E	'95 →	
			CL	'06 →	
			CLC	'08 →	
			CLK	'02 →	
			CLS	'04 →	
			G	'06 →	
			GL	'06 →	
			ML	'98 →	
			R	'06 →	
			S	'96 →	
			SL	'96 →	
			SLK	'04 →	
			VANEO	'07 →	
		VARIO	'03 →		
		VIANO	'03 →		

MERCURY

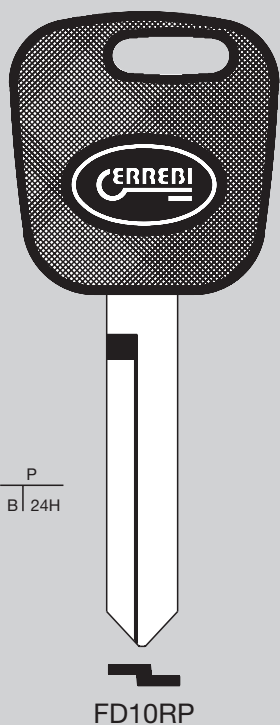

P
B | 24H

FD10RP

TX1	FD10RP	←	COUGAR MISTIQUE	'99 → '96 →	<p>LS7 LS8</p>

MERCURY



P
B | 24H

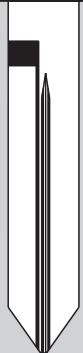

....X
1-1706

FD16RP

STRATTEC

TX1	FD16RP	←	GRAND MARQUIS MOUNTAINEER SABLE	'98 → '02 '98 → '02 '96 → '00	 LS7 LS8

MERCURY



P
B | 24K









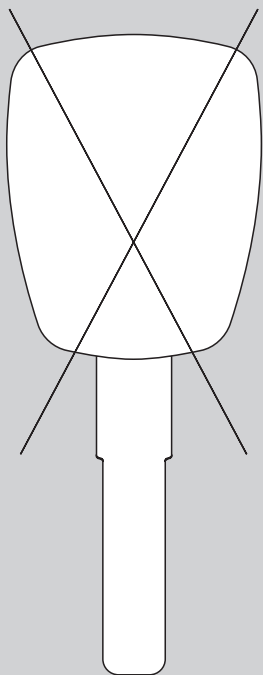

FD21P

STRATTEC

TX2	FD21P	←	GRAND MARQUIS MARAUDER MARINER MILAN MONTEGO MONTEREY MOUNTAINEER SABLE	'02 → '03 → '05 → '06 → '05 → '04 → '02 → '00 →	 LS7 + TPX LS8







MERCURY

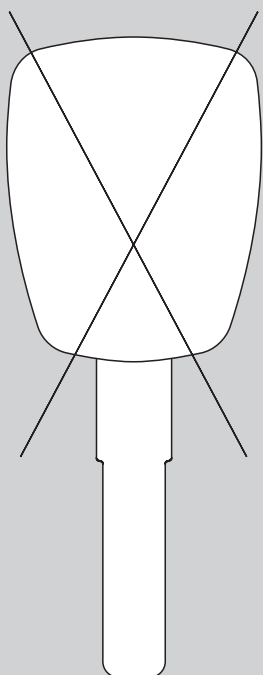

					
ORIGINAL			GRAND MARQUIS	'11 →	
			MARINER	'11 →	
			MILAN	'11 →	
			MOUNTAINEER	'11 →	

MINI



					
ORIGINAL			COUNTRYMAN	'10 →	
			MINI COOPER	'01 →	
			NEW MINI	'06 →	
			T	'07 →	

MITSUBISHI

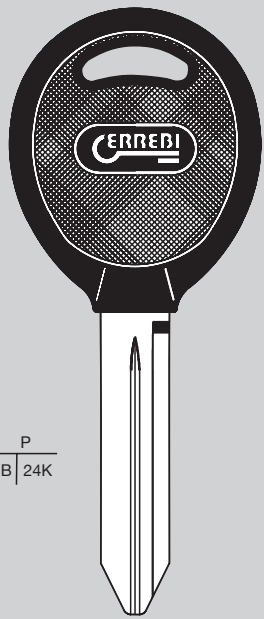

P
B 24K

L...
1-3580
ERREBI
CY62P

CHRYSLER

TX4	CY62P	←	RAIDER	'06 → '08	 LS7 + TX4 TECH LS8

MITSUBISHI

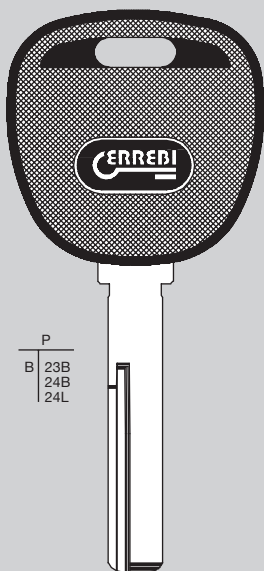

P
B 23B
24B
24L

ERREBI
HF49P

HUF

T01 T05	HF49P	←	CARISMA	'96 → '00	
ORIGINAL		T00HF49P	CARISMA	'96 → '00	
TX4	HF49P	←	COLT SPACE STAR	'04 → '99 → '05	 LS7 + TX4 TECH LS8

MITSUBISHI



P
B | 24L

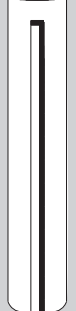

KIA7P

KIA

TX4	KIA7P	←	MAGNA	'99 → '05	 LS7 + TX4 TECH LS8

MITSUBISHI



P
B | 24H



E...
5001-7679
MIT7P

MITSUBISHI

TX1	MIT7P	←	ECLIPSE EXPRESS FOCUS GALANT MONTERO NIMBUS PAJERO SHOGUN SPACE GEAR SPACE RUNNER SPACE WAGON	'96 → '00 '96 → '98 → '98 → '00 '96 → '00 '98 → '99 '96 → '99 '96 → '00 '96 → '98 → '99 '98 → '99	 LS7 LS8

MITSUBISHI



P
B | 24K

E....
5001-7679
MIT7P

MITSUBISHI

TX2	MIT7P	←	CHALLENGER DIAMANTE ECLIPSE GALANT L200 MONTERO PAJERO SHOGUN	'02 → '03 '03 → '00 → '03 '03 → '02 → '06 '02 → '02 → '02 → '05	 LS7 + TPX LS8

MITSUBISHI



B
B | 24L

E
5001-7679
7001-7700

MIT7PB

MITSUBISHI

TX2	MIT7PB	←	CHALLENGER DIAMANTE L200 MONTERO OUTLANDER PAJERO SHOGUN SPACE STAR SPACE WAGON TRITON	'99 → '02 '02 → '03 '99 → '02 '99 → '03 '00 → '03 '99 → '03 '99 → '02 '99 → '99 → '99 →	 LS7 + TPX LS8

MITSUBISHI

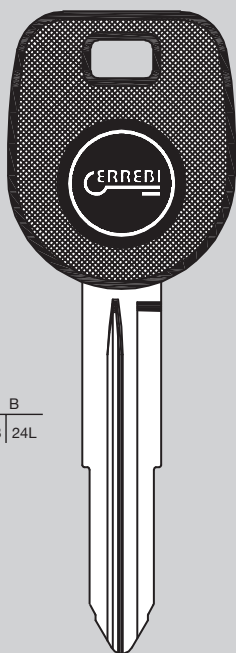







B
B | 24L

E
5001-7679
7001-7700

MIT7PB

MITSUBISHI

					
TX4	MIT7PB	←	L200 MONTERO PAJERO	'96 → '06 → '06 →	 LS7 + TX4 TECH LS8

MITSUBISHI

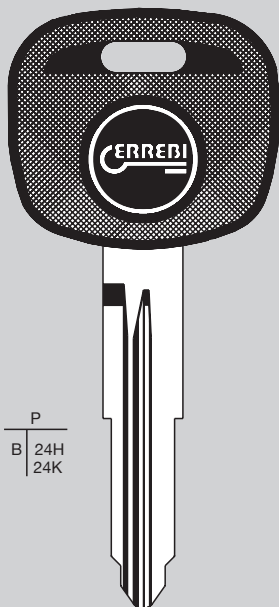







P
B | 24H
B | 24K

.....
30010-32009

MIT8RP

MITSUBISHI

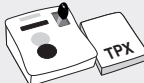
					
TX1	MIT8RP	←	COLT LANCER MIRAGE	'96 → '00 '96 → '03 '96 →	 LS7 LS8
TX2	MIT8RP	←	LANCER OUTLANDER SHOGUN PININ	'03 → '03 → '05 '99 →	 LS7 + TPX LS8

mitsubishi



B
B | 24H
24K

30010-32009

MIT8RPB

mitsubishi

TX1	MIT8RPB	←	COLT LANCER MIRAGE	'96 → '00 '96 → '03 '96 →	 LS7 LS8
TX2	MIT8RPB	←	LANCER OUTLANDER SHOGUN PININ	'03 → '03 → '05 '99 →	 LS7 + TPX LS8

mitsubishi



B
B | 24K

30010-32009

MIT8RPB

mitsubishi

TX4	MIT8RPB	←	380 ECLIPSE ENDEAVOR GALANT GRANDIS LANCER OUTLANDER	'06 → '06 → '06 → '06 → '03 → '06 → '06 →	 LS7 + TX4 TECH LS8

MITSUBISHI



P
B | 24B



MIT13P

MITSUBISHI

T01	MIT13P	←	MAGNA	'96 → '99	
T05					

MITSUBISHI



P
B | 24K



F...1-1571
MIT15P

MITSUBISHI

TX2	MIT15P	←	ECLIPSE ENDEAVOR GALANT RAIDER	'00 → '03 '04 → '05 '00 → '03 '06 →	 LS7 + TPX LS8

MITSUBISHI

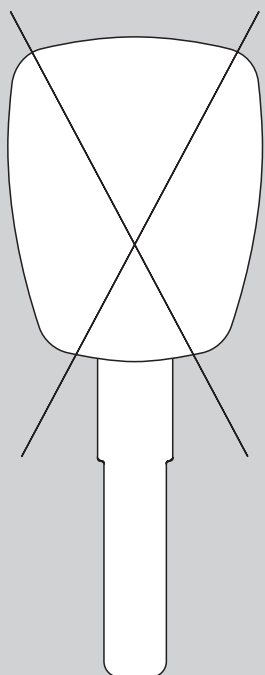

MITSUBISHI

ORIGINAL			3000 GT COLT LANCER TURBO NIMBUS SPACE RUNNER	'06 → '01 '00 → '03 '03 → '06 '99 → '99 →	

MITSUBISHI (AUS)

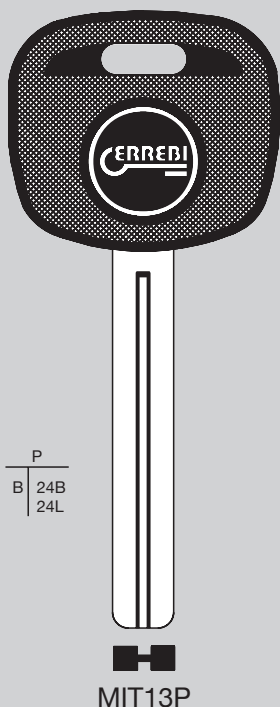

MITSUBUSHI

T01 T05	MIT13P	←	VERADA	'96 → '00	
TX2	MIT13P	←	VERADA	'00 → '03	 LS7 + TPX LS8

MITSUBISHI (USA)

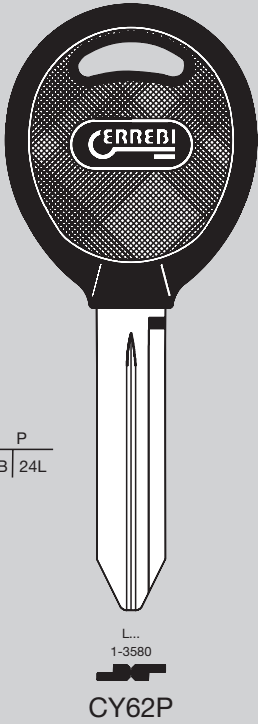

CHRYSLER

TX4	CY62P	←	RAIDER	'06 →	 LS7 + TX4 TECH LS8

MITSUBISHI (USA)

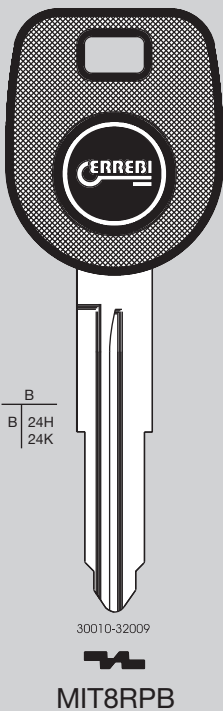

MITSUBISHI

TX4	MIT8RPB	←	ECLIPSE ENDEAVOR GALANT LANCER OUTLANDER	'07 → '07 → '07 → '08 → '04 →	 LS7 + TX4 TECH LS8
TX2	MIT8RPB	←	LANCER EVO	'03 →'11	 LS7 + TPX LS8

MITSUBISHI (USA)



P
B | 24K
24L



F...1-1571



MIT15P

MITSUBUSHI

TX2	MIT15P	←	ECLIPSE ENDEAVOR GALANT	'00 → '05 '04 → '05 '00 → '03	 LS7 + TPX LS8
TX4	MIT15P	←	ECLIPSE ENDEAVOR GALANT	'06 → '07 '06 → '04 → '05	 LS7 + TX4 TECH LS8

MITSUBUSHI (USA)



B
B | 24L



E

5001-7679
7001-7700



MIT7PB

MITSUBUSHI

TX2	MIT7PB	←	DIAMANTE MONTERO	'00 → '06 '00 → '06	 LS7 + TPX LS8

MORGAN

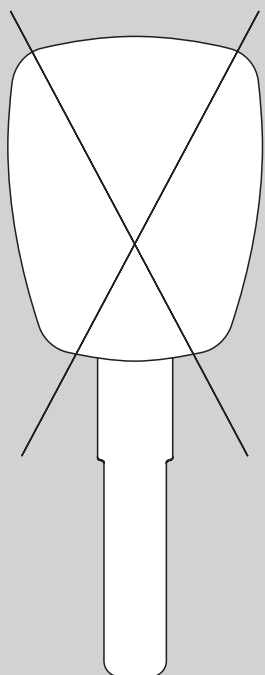

MITSUBISHI

ORIGINAL			4 / 4 AERO 8 PLUS 4 ROADSTER	'06 → '06 → '06 → '06 →	

NISSAN

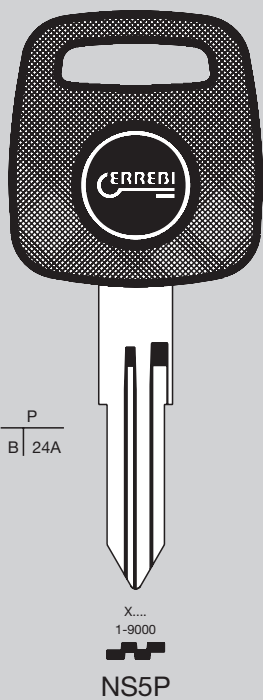

P
B | 24A

X....
1-9000
NS5P

NISSAN

T01 T05	NS5P	←	MARCH MAXIMA MICRA NX ALMERA PRIMERA PULSAR SERENA SUNNY TERRANO II VANETTE	'96 → '98 '96 → '98 '96 → '98 '95 → '98 '95 → '97 '95 → '96 '96 → '98 '96 → '95 → '98 '96 → '99	

NISSAN



P
B 24H
24K

X...
1-9000
NS5P

NISSAN

TX1	NS5P	←	NX ALMERA	'95 → '98	 LS7 LS8
TX3	NS5P	←	MARCH MAXIMA MICRA NX ALMERA TERRANO II	'98 → '00 '99 → '00 '99 → '00 '98 → '00 '98 →	 LS7 + TPX LS8

NISSAN



P
B 24K
24L

X...
1-9000
NS5P

NISSAN

TX2	NS5P	←	MARCH MAXIMA MICRA SERENA TERRANO II VANETTE	'00 → '01 → '00 → '03 '00 → '02 → '99 →	 LS7 + TPX LS8
TX4	NS5P	←	MICRA	'03 →	 LS7 + TX4 TECH LS8

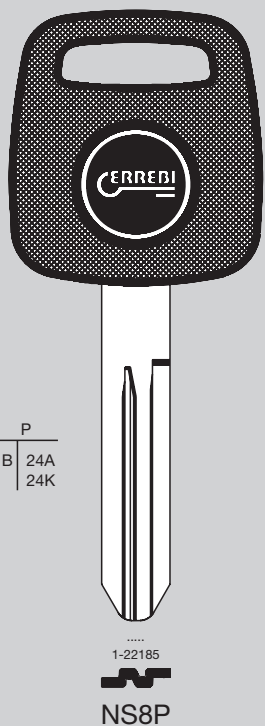
NISSAN

NISSAN

T01 T05	NS8P	←	PRIMERA PULSAR	'97 → '98 '97 → '98	
TX3	NS8P	←	PATROL PRIMERA PULSAR X-TRAIL	'99 → '02 '00 → '02 '00 → '98 → '00	 LS7 + TPX LS8

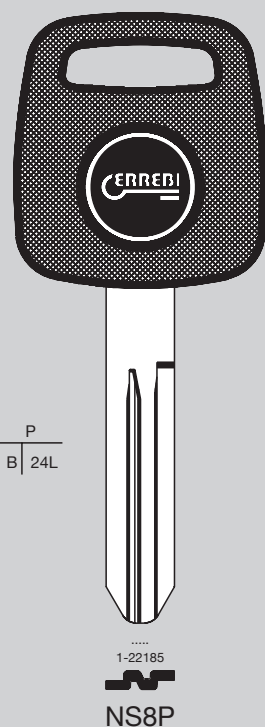
NISSAN

NISSAN

TX4	NS8P	←	ALMERA TINO JUKE MICRA NOTE NP 300 PATHFINDER PRIMERA QASHQAI QUEST	'04 → '10 → '03 → '06 → '10 → '05 → '02 → '07 → '04 →	 LS7 + TX4 TECH LS8

NISSAN



P
B | 24D

1-22185
NS8P

NISSAN

T12	NS8P	←	ALTIMA NAVARA QUEST TITAN X-TERRA	'05 → '06 → '04 → '04 → '05 →	

NISSAN



P
B | 24K

1-22185
NS8P

NISSAN

TX2	NS8P	←	350-Z ALMERA ALTIMA ARMADA FRONTIER MURANO NAVARA PATHFINDER PATROL GR	'03 → '00 → '00 → '05 '04 → '02 → '03 → '07 '03 → '06 '99 → '05 '03 →	<p>LS7 + TPX LS8</p>

NISSAN









P
B | 24K

.....
1-22185

NS8P

NISSAN

					
TX2	NS8P	←	PRIMERA PULSAR SENTRA STANZA X-TERRA X-TRAIL	'98 → '00 '98 → '00 '00 → '00 → '00 → '05 '00 → '06	 LS7 + TPX LS8







NISSAN



P
B | 24L

NS11RP

NISSAN

					
TX4	NS11RP	←	PIXO	'09 →	 LS7 + TX4 TECH LS8

NISSAN

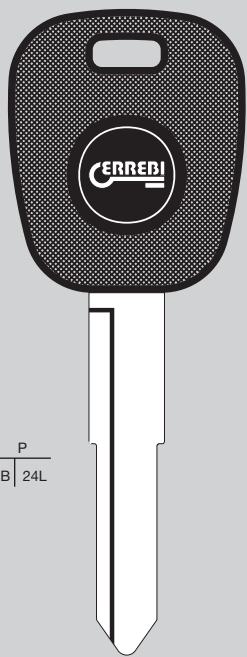

P
B | 24L



SZ15P

SUZUKI

TX4	SZ15P	←	PIXO	'09 →	 LS7 + TX4 TECH LS8

NISSAN



P
N | 24L



VA1P

VALEO

TX4	VA1P	←	NV400	'11 →	 LS7 + TX4 TECH LS8

NISSAN

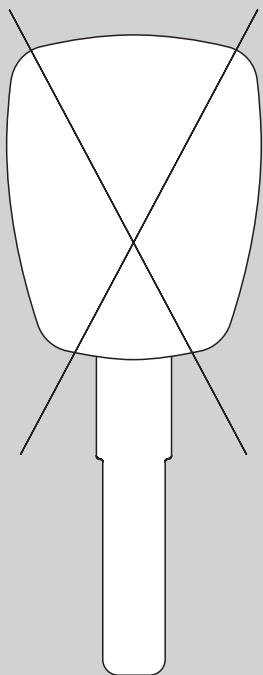

ORIGINAL			CEFIRO	'00 →	
			INFINITY	'97 →	
			LAUREL	'99 →	
			MURANO	'08 →	
			NV200	'09 →	
			PLATINA	'01 →	
			PRIMASTAR	'03 →	
			TINO	'00 →	
			VERSA	'06 →	
			X-TRAIL	'07 →	
			Z	'05 →	

OLDSMOBILE

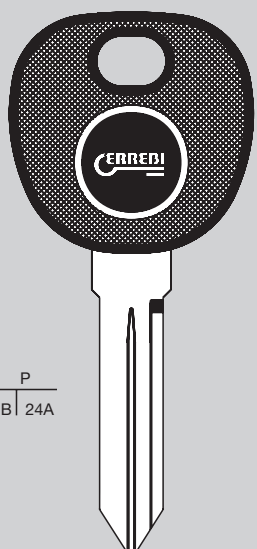

P
B | 24A

H....
1-3988

GM33P

T05	GM33P	←	SILHOUETTE	'99 →	

G.M.

OLDSMOBILE

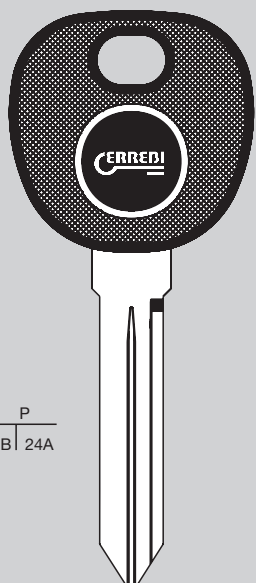

P
B | 24A

H...
1-3988
GM34P

G.M.

T05	GM34P	←	AURORA	'00 →	

OPEL-VAUXHALL



P
B | 24L

V...
1-1200
DW1P

DAEWOO

TX4	DW1P	←	ANTARA	'07 →	 LS7 + TX4 TECH LS8

OPEL-VAUXHALL



P
B | 24A

N...
5001-7000

GM10P

G.M.

					
T01	GM10P	←	FRONTERA	'96 → '99	
T05					

OPEL-VAUXHALL

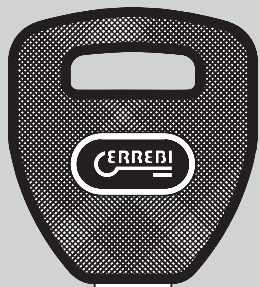



P
B | 24C

...5001-8442

HD43RP

HONDA

					
T08	HD43RP	←	FRONTERA	'99 →	 TRACK 7

OPEL-VAUXHALL



P
B | 24B
24D
24L



H....
WH....
1-3000

HF42P

HUF-YMOS

T01 T05	HF42P	←	CALIBRA OMEGA SINTRA VECTRA	'95 → '95 → '98 '96 → '98 '95 → '98	
T09	HF42P	←	OMEGA SINTRA VECTRA	'98 → '03 '98 → '01 '98 → '01	 TRACK 7
TX4	HF42P	←	SIGNUM VECTRA	'03 → '05 '02 → '04	 LS7 + TX4 TECH LS8

OPEL-VAUXHALL



A
B | 23M



H....
WH....
1-3000

HF42PA

HUF

ORIGINAL		T00HF42PA	OMEGA SINTRA VECTRA ZAFIRA	'98 → '98 → '98 → '01 '98 → '01	

OPEL-VAUXHALL



P
B | 24A
24D

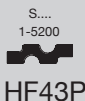

S....
1-5200
HF43P



D....
1-5200
YM24P

HUF-YMOS

T01	HF43P	←	ASTRA	'95 → '98	
T05	YM24P		CORSA TIGRA	'95 → '98 '95 → '98	
	HF43P	←	COMBO	'95 → '98	
T09	HF43P YM24P	←	ASTRA COMBO CORSA MERIVA OMEGA SPEEDSTER TIGRA ZAFIRA	'98 → '04 '98 → '03 '98 → '04 '02 → '04 '98 → '03 '98 → '04 '98 → '02 '02 → '04	 TRACK 7

OPEL-VAUXHALL



P
B | 23M

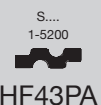

S....
1-5200
HF43PA



D....
1-5200
YM24PA

HUF

ORIGINAL		T00HF43PA	ASTRA COMBO CORSA SPEEDSTER TIGRA ZAFIRA	'98 → '04 '98 → '98 → '00 '01 → '98 → '02 '99 → '04	
		T00YM24PA	ASTRA CORSA OMEGA TIGRA	'98 → '04 '98 → '00 '98 → '99 '98 → '02	

OPEL-VAUXHALL

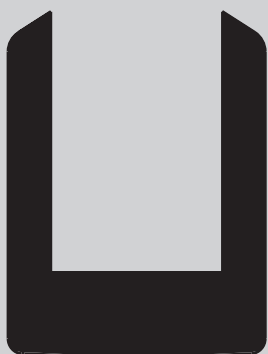

B
B | 23M



HF43PB

HUF

ORIGINAL		T00HF43PB	CORSA MERIVA	'01 → '04 '02 → '04	

OPEL-VAUXHALL



P
B | 24D

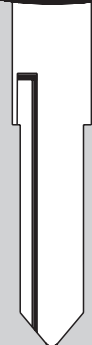

HF60P

HUF

T09	HF60P	←	AGILA	'00 → '04	

OPEL-VAUXHALL

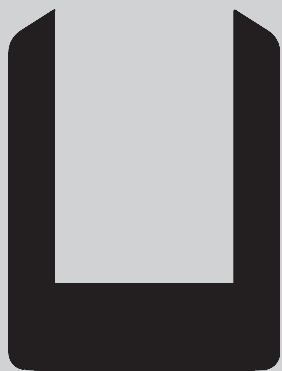

P
B | 23M

Z...1-2000
Z...4001-6000

HF66P

HUF

ORIGINAL		T00HF66P	AGILA COMBO CORSA MERIVA TIGRA ZAFIRA	'04 → '04 → '04 →'05 '04 →'10 '04 → '05 →	

OPEL-VAUXHALL



B
N | 24D
24L

HF66PB

HUF

T09	HF66PB	←	AGILA CORSA MERIVA TIGRA ZAFIRA	'05 →'07 '04 →'06 '04 →'10 '04 → '04 →'05	
TX4	HF66PB	←	ASTRA CORSA INSIGNA MERIVA SIGNUM VECTRA ZAFIRA	'04 → '06 → '08 → '10 → '03 → '04 → '06 →	 LS7 + TX4 TECH LS8

OPEL-VAUXHALL



B
B | 23M

Z...
1-2000
2001-4000
4001-6000



HF66PC

HUF

ORIGINAL		T00HF66PC	AGILA MERIVA	'04 → '04 →	

OPEL-VAUXHALL



P
B | 24A
24L

...1/9...
1/9...A/Z
.1/9...A/Z
..1/9...A/Z
...1/9...A/Z
....1/9...A/Z
.....1/9...A/Z
....1/9...A/Z A/Z
M-N-P-R-S

NE79P

NEIMAN

T01 T05	NE79P	←	MOVANO	'99 → '02	
TX4	NE79P	←	MOVANO VIVARO	'02 → '10 '02 →	 LS7 + TX4 TECH LS8

OPEL-VAUXHALL

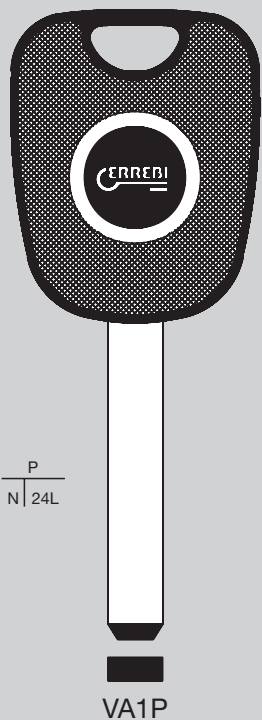

P
N | 24L

VA1P

VALEO

TX4	VA1P	←	MOVANO	'11 →	 LS7 + TX4 TECH LS8

OPEL-VAUXHALL

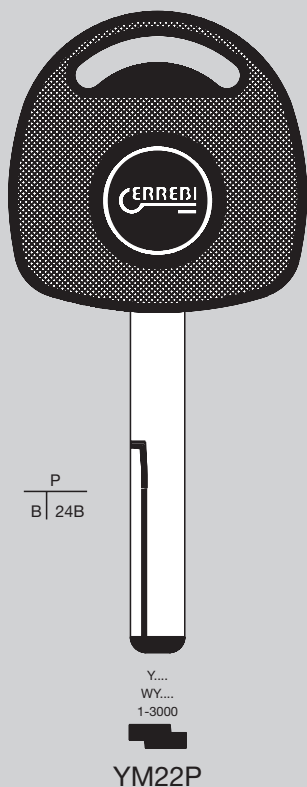

P
B | 24B

Y...
WY...
1-3000
YM22P

YMOS

T01 T05	YM22P	←	CALIBRA OMEGA VECTRA	'95 → '95 →'98 '95 →'98	

OPEL-VAUXHALL

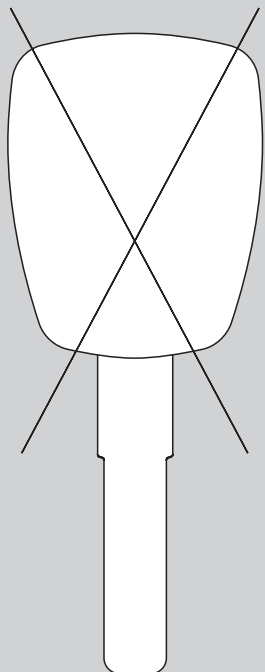

			ARENA MONARO	'00 → '04 '03 →	

PANOZ

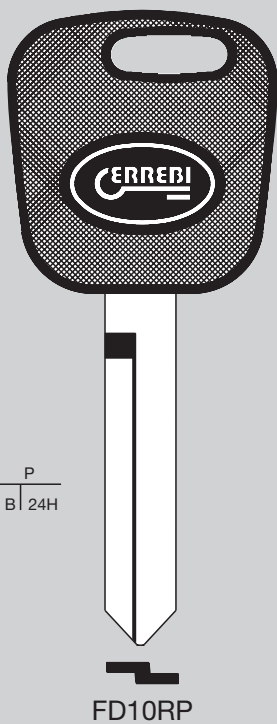

P
B | 24H

FD10RP

TX1	FD10RP	←	AIV ROADSTER	'95 → '96	 LS7 LS8

PANOZ



P
B | 24H

...X
1-1706

FD16RP

STRATTEC

TX1	FD16RP	←	AIV ROADSTER ESPERANTE	'96 → '00 '01 → '06	 LS7 LS8

PANOZ



P
B | 24K

FD21P

STRATTEC

TX2	FD21P	←	ESPERANTE	'07 →	 LS7 + TPX LS8

PEUGEOT



P
B | 24A

N....6001-7000
J....3001-6732
V....1-3051
V....5001-8058
AB....6001-6891

GB9RP

GIOBERT-TRW-SIPEA

T02 T05	GB9RP	←	BOXER	'96 → '01	

PEUGEOT

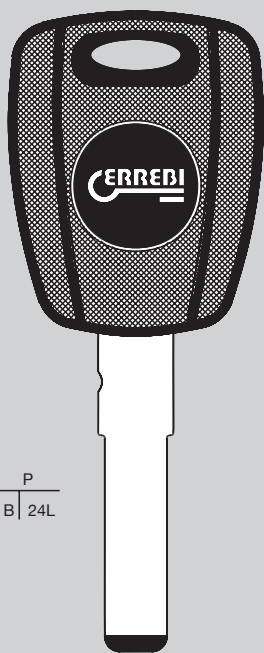

P
B | 24L

GB18P

GIOBERT-TRW-SIPEA

TX4	GB18P	←	BIPPER BOXER	'09 → '06 →	 LS7 + TX4 TECH LS8

PEUGEOT

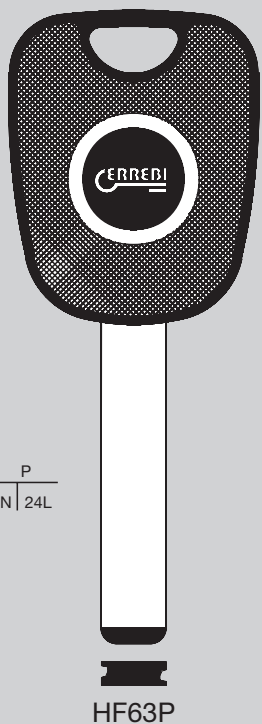

HF63P

HUF

TX4	HF63P	←	207 307 308 807 3008 5008 EXPERT RCZ	'06 → '01 → '07 → '02 → '09 → '09 → '07 → '10 →	 LS7 + TX4 TECH LS8

PEUGEOT

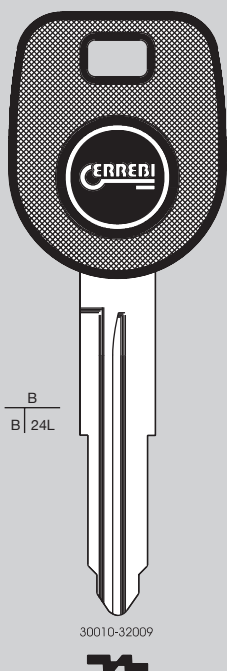

MIT8RPB

HUF

TX4	MIT8RPB	←	4007	'07 →	 LS7 + TX4 TECH LS8

PEUGEOT

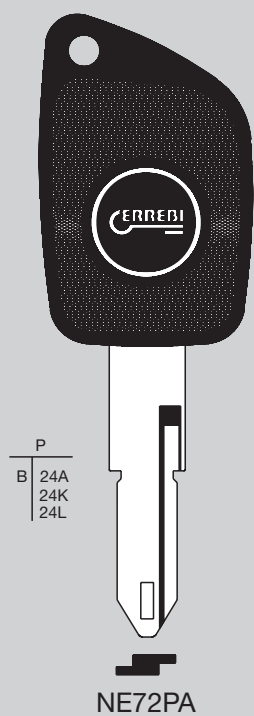

NEIMAN

T01	NE72PA	←	106		'97 → '00		
T05			306		'97 →		
TX3	NE72PA	←	206		'98 → '00		
						LS7 + TPX LS8	
TX4	NE72PA	←	106		'00 →		
			206		'00 →	LS7 + TX4 TECH LS8	

PEUGEOT

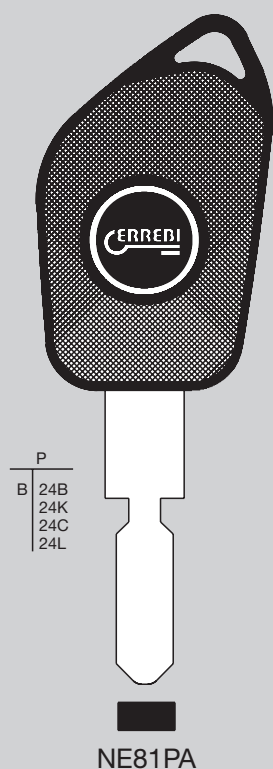

NEIMAN

T01	NE81PA	←	406		'97 → '99		
T05							
TX3	NE81PA	←	406		'99 → '01		
						LS7 + TPX LS8	
T08	NE81PA	←	607		'01 → '04		
						TRACK 7	
TX4	NE81PA	←	406		'01 →		
			607		'04 →	LS7 + TX4 TECH LS8	

PEUGEOT



P
N 24B
24L

111111-628888



SM7P

SIMPLEX

T01 T05	SM7P	←	806 EXPERT PARTNER RANCH	'97 → '02 '98 → '01 '98 → '00 '98 → '00	
TX4	SM7P	←	EXPERT	'02 → '08	 LS7 + TX4 TECH LS8

PEUGEOT

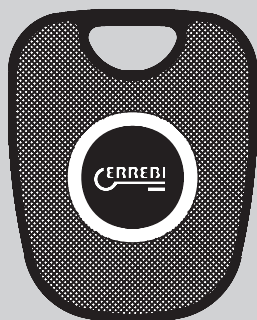

P
N 24L
24K

VA1P

VALEO

TX2	VA1P	←	107	'05 →	 LS7 + TPX LS8
TX4	VA1P	←	407 1007 PARTNER RANCH	'04 → '05 → '02 → '01 → '07	 LS7 + TX4 TECH LS8

PEUGEOT

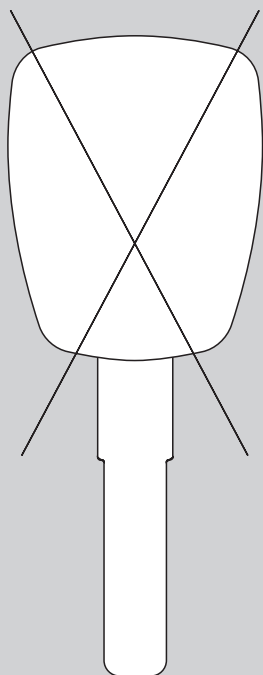

ORIGINAL			BOXER	'02 → '05	

PLYMOUTH

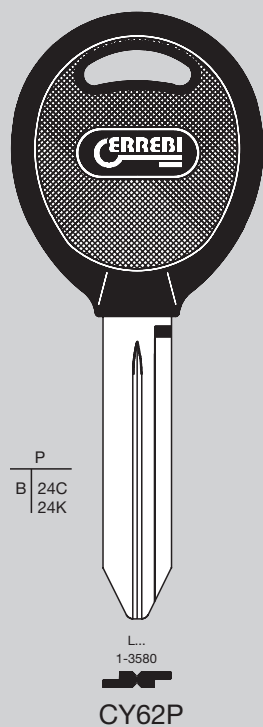

T06	CY62P	←	BREEZE	'99 → '03	
TX2	CY62P	←	NEON VOYAGER	'00 → '01 '01 → '03	 LS7 + TPX LS8

PONTIAC









P
B | 24C

T...
1-1200

DW1RP

DAEWOO





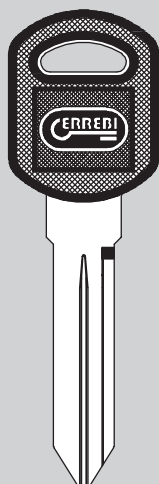

					
T08	DW1RP	←	G3	'09 →	 TRACK 7

PONTIAC





GM33P

G.M.

					
T05	GM33P	←	MONTANA TRANS SPORT	'99 → '05 '99 →	

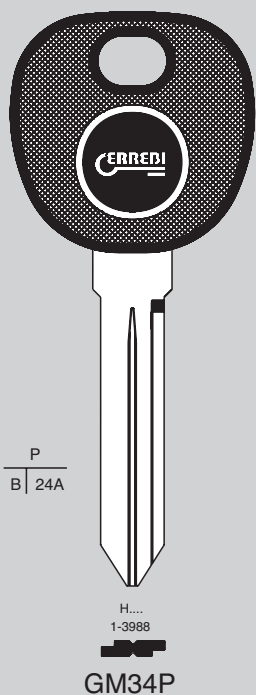
PONTIAC



G.M.

T05	GM34P	←	AZTEK BONNEVILLE MONTANA	'01 → '00 → '07 →	

PONTIAC

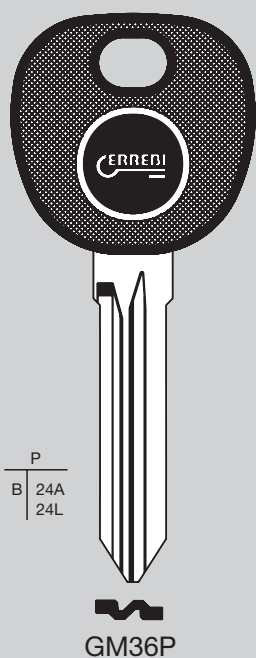

G.M.

T05	GM36P	←	GRAND PRIX MONTANA	'04 → '08 '05 → '06	
TX4	GM36P	←	G5 G6 PURSUIT SOLSTICE TORRENT	'07 → '05 → '06 → '06 → '07 →	 LS7 + TX4 TECH LS8

PONTIAC

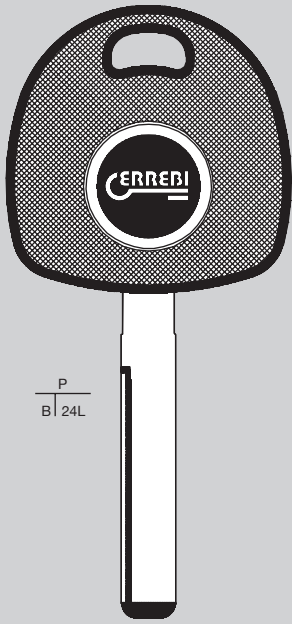

P
B | 24L

GM37P

G.M.

TX4	GM37P	←	G8	'06 →	 LS7 + TX4 TECH LS8

PONTIAC



P
B | 24K

1...
1-5000
TY37RP

TOYOTA

TX2	TY37RP	←	VIBE	'07 →	 LS7 + TPX LS8

PORSCHE



P
B 24B
23B
24L

AH...
1-8154
1001-9282

HF55P

HUF

T01 T05	HF55P	←	911 BOXTER	'98 → '99 '98 → '99	
ORIGINAL		T00HF55P	911 968 BOXTER PANAMERA	'99 → '99 → '98 → '09 →	
TX4	HF55P	←	CAYENNE CAYMAN	'03 → '06 →	 LS7 + TX4 TECH LS8

PROTON



P
B 24H
23A

.....
30010-32005
PT1RP

PROTON

TX1	PT1RP	←	415 416	'96 → '98 '96 → '98	 LS7 LS8
ORIGINAL		T00PT1RP	415 416	'98 → '98 →	

RENAULT



P
B 24A

...1/9...
1/9...A/Z
.1/9...A/Z
..1/9...A/Z
...1/9...A/Z
....1/9...A/Z
.....1/9...A/Z
...1/9...A/Z A/Z
M-N-P-R-S

NE79P

NEIMAN

T01	NE79P	←	CLIO	'98 → '00	
T05			ESPACE	'97 → '98	
			LAGUNA	'96 → '99	
			MASTER	'99 → '01	
			MEGANE	'96 → '98	
			SAFRANE	'95 → '98	
			SCENIC	'96 → '98	

RENAULT



P
B 24K
24L

...1/9...
1/9...A/Z
.1/9...A/Z
..1/9...A/Z
...1/9...A/Z
....1/9...A/Z
.....1/9...A/Z
...1/9...A/Z A/Z
M-N-P-R-S

NE79P

NEIMAN

TX2	NE79P	←	AVANTIME	'02 →	
			LAGUNA	'99 → '00	
			MEGANE	'98 → '02	
			SCENIC	'98 → '03	
TX4	NE79P	←	CLIO II	'01 → '05	
			MASTER	'02 → '10	
			TRAFIC	'02 →	

RENAULT

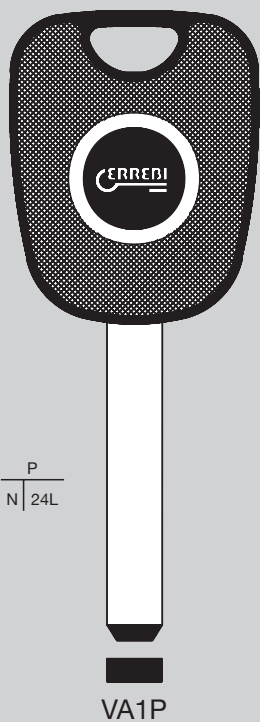

P
N | 24L

VA1P

VALEO

TX4	VA1P	←	CLIO III MASTER MODUS TWINGO	'06 → '11 → '04 → '07 →	 LS7 + TX4 TECH LS8

RENAULT

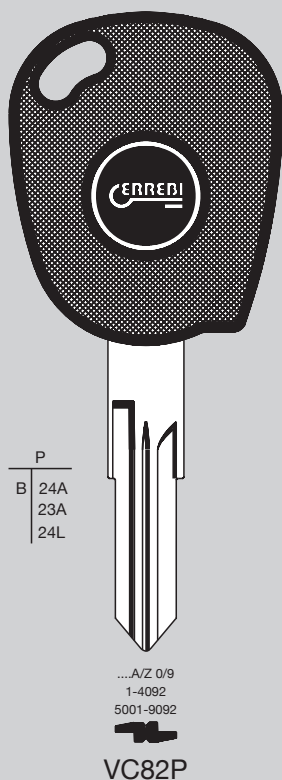

P
B | 24A
23A
24L

...A/Z 0/9
1-4092
5001-9092

VC82P

VACHETTE

T01 T05	VC82P	←	CLIO KANGOO LAGUNA TWINGO	'95 → '98 '97 → '00 '96 → '99 '95 → '98	
ORIGINAL		T00VC82P	KANGOO	'01 → '02	
TX4	VC82P	←	KANGOO TWINGO	'02 → '02 →	 LS7 + TX4 TECH LS8

RENAULT

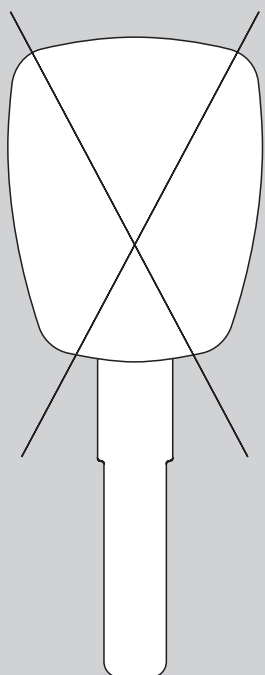

ORIGINAL			ESPACE	'98 →	
			KOLEOS	'08 →	
			LAGUNA II	'01 →	
			MEGANE	'03 →	
			SAFRANE	'98 →	
			SCENIC	'03 →	
			VEL SATIS	'02 →	

ROVER

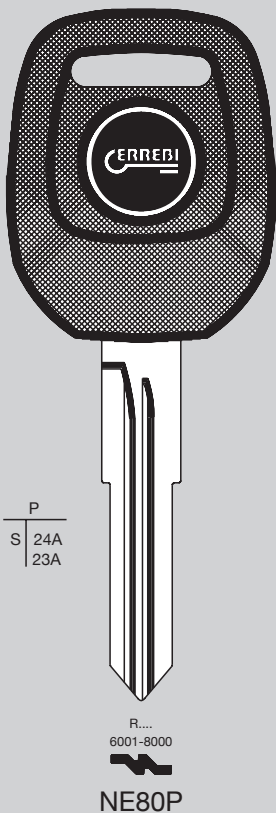

T01	NE80P	←	SERIE 400	'97 →	
T05			SERIE 600	'96 →	
			SERIE 800	'96 →	
ORIGINAL		T00NE80P	25 45	'98 → '98 →	

ROVER

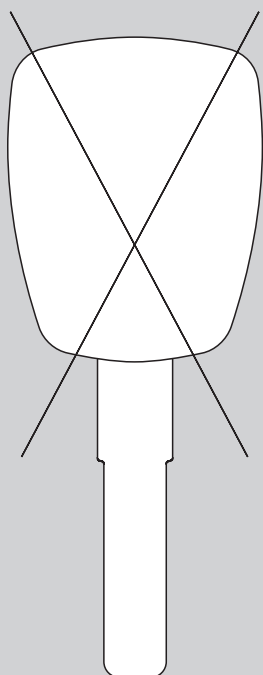

ORIGINAL

			75	'99 →	

SAAB

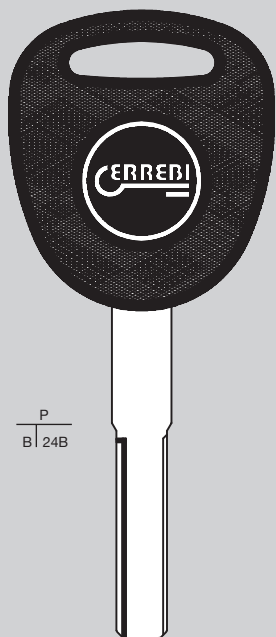

P
B | 24B

YM26RP

YMOS

T02	YM26RP	←	9 - 3	'98 → '03	
T05			9 - 5	'98 → '03	

SAAB

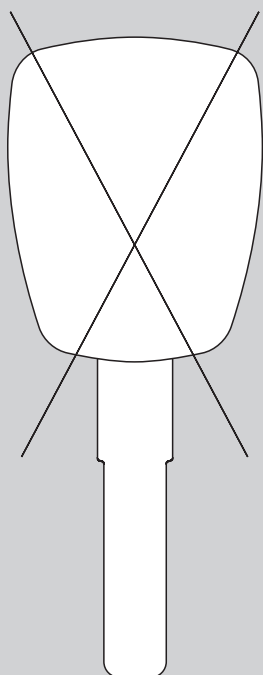

ORIGINAL			9 - 3 9 - 5 9 - 7X	'03 → '03 → '06 →	

SATURN



P
B | 24L

V...
1-1200

DW1P

TX4	DW1P	←	VUE	'08 →	 LS7 + TX4 TECH LS8

DAEWOO

SATURN

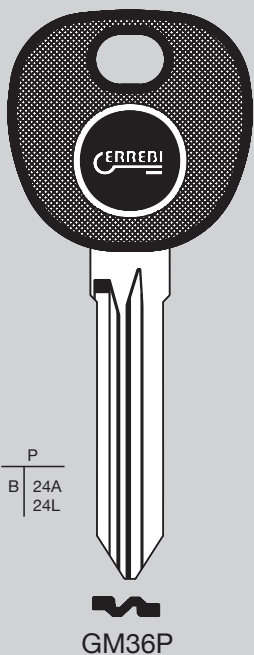

P
B | 24A
24L

GM36P

G.M.

TX4	GM36P	←	AURA OUTLOOK SKY	'07 → '07 → '06 →	 LS7 + TX4 TECH LS8
T05	GM36P	←	RELAY	'05 →	

SATURN

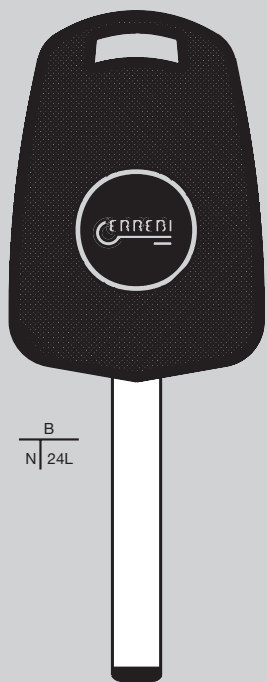

B
N | 24L

Z...1-2000
Z...4001-6000

HF66PB

HUF

TX4	HF66PB	←	ASTRA	'08 →	 LS7 + TX4 TECH LS8

SCION



P
B | 24L

1...
1-5000

TY37RP

TOYOTA

TX4	TY37RP	←	TC XA XB XD	'05 → '04 → '04 → '08 →	 LS7 + TX4 TECH LS8

SEAT



P
B | 24A

AH...
1-8154
1001-9282

HF44P

HUF

T02 T05	HF44P	←	CORDOBA IBIZA INCA TOLEDO VARIO	'95 → '98 '95 → '98 '96 → '98 '95 → '98 '97 → '98	
T02 TEMIC	HF44P	←	MARBELLA	'97 →	

SEAT



P
B | 24B
| 24K

AH....
1-8154
1001-9282

HF55P

HUF

T02 T05	HF55P	←	ALHAMBRA AROSA	'96 → '98 '96 → '98	
TX3	HF55P	←	ALHAMBRA AROSA CORDOBA IBIZA INCA VARIO	'98 → '00 '98 → '00 '98 → '02 '98 → '99 '98 → '00 '98 → '99	 LS7 + TPX LS8

SEAT



P
B | 24B

AH....
1-8154
1001-9282

HF55P

HUF

T08	HF55P	←	ALTEA CORDOBA IBIZA LEON TOLEDO VARIO	'04 → '05 '02 → '99 → '08 '00 → '05 '98 → '04 '99 → '02	 TRACK 7

SEAT

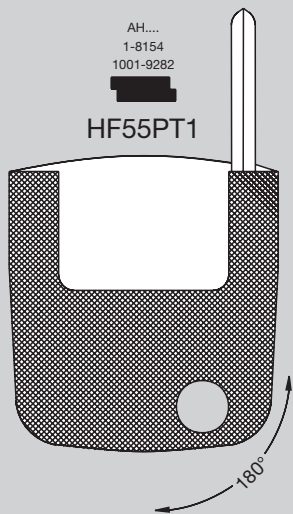

AH...
1-8154
1001-9282

HF55PT1

T1
N | 23J

HUF

ORIGINAL		T00HF55PT1	ALHAMBRA ALTEA AROSA CORDOBA IBIZA INCA LEON TOLEDO VARIO	'00 → '04 →'05 '00 → '99 → '99 → '00 → '00 →'05 '98 →'04 '99 →	
			ALTEA LEON TOLEDO	'05 → '05 → '05 →	 (****) Pin code

SKODA



P
B | 24A

4AE...
1-2780

F33RP

FAB

T02 T05	F33RP	←	FELICIA	'96 →'99	
T01 T05	F33RP	←	PICK UP	'95 → '98	

SKODA

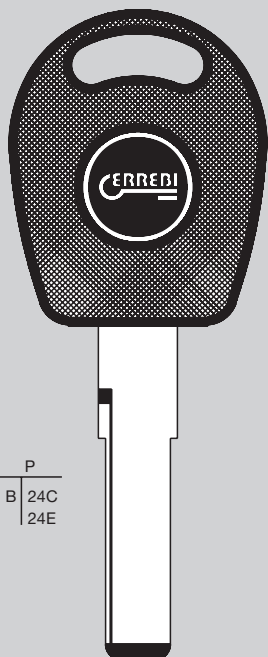

P
B | 24C
| 24E

AH...
1-8154
1001-9282

HF55P

HUF

T08	HF55P	←	FABIA FELICIA OCTAVIA SUPERB	'00 → '99 → '98 →'04 '92 →'08	 TRACK 7
T24	HF55P	←	OCTAVIA ROOMSTER ROOMSTER SCOUT	'04 → '06 → '07 →	 CAR CONCESSIONARY (*****) Pin code

SKODA

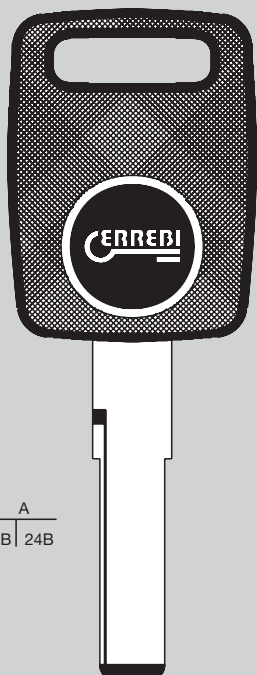

A
B | 24B

AH...
1-8154
1001-9282

HF55PA

HUF

T02 T05	HF55PA	←	OCTAVIA	'97 →'98	
T01 T05	HF55PA	←	PICK UP	'98 →	

SKODA

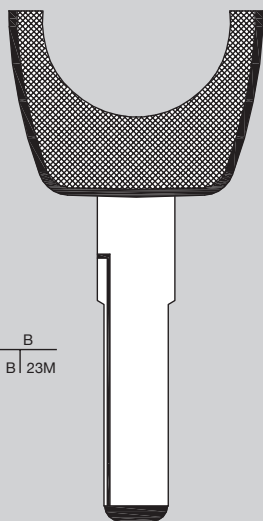

B
B | 23M

HF55PB

HUF

ORIGINAL		T00HF55PB	FELICIA OCTAVIA	'99 → '97 →	

SKODA

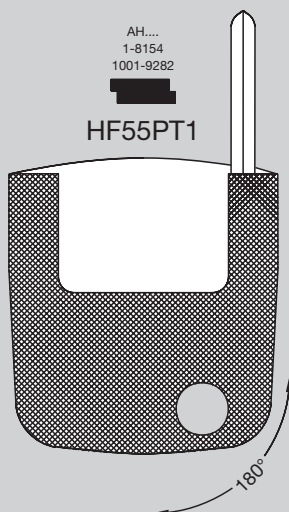

AH...
1-8154
1001-9282

HF55PT1

T1
N | 23J

HUF

ORIGINAL		TH00F55PT1	FABIA FELICIA OCTAVIA SUPERB	'02 → '02 → '02 → '04 '02 →	
			OCTAVIA	'04 →	 (****) Pin code

MCC-SMART

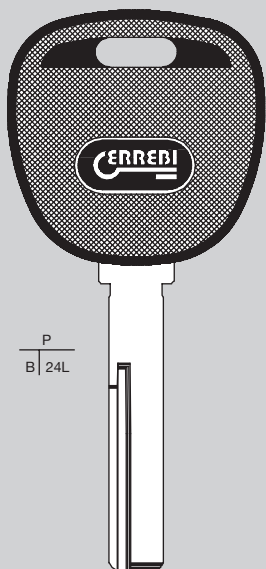

P
B | 24L



HF49P

HUF

TX4	HF49P	←	FORFOUR	'04 → '06	 LS7 LS8

MCC-SMART

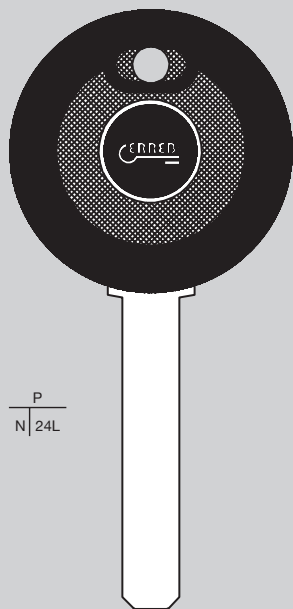

P
N | 24L

M...
1-1200

SMR1P

SMART

TX4	SMR1P	←	FORFOUR FORTWO	'06 → '09 →	 LS7 + TX4 TECH LS8

SSANGYONG

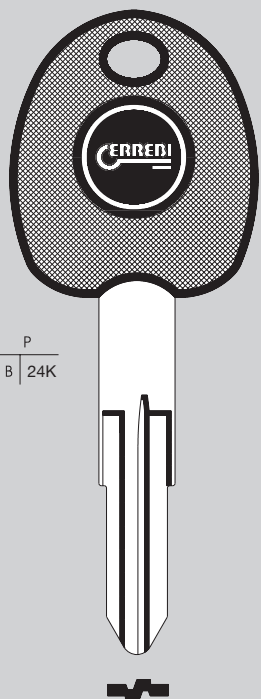

P
B | 24K

SSA2P

SSANGYONG

TX2	SSA2P	←	ACTYON KYRON REXTON	'06 → '05 → '06 →	 LS7 + TPX LS8

SSANGYONG

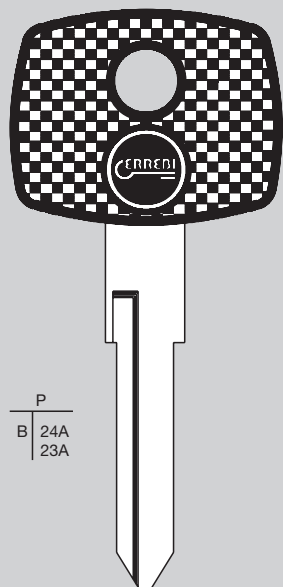

P
B | 24A
23A

HM...1-1200
2501-3500
4001-5795
5801-7350
NF...1-1200
...NF...
01-99/01/99

YMNFP

YMOS

T01 T05	YMNFP	←	MUSSO	'97 →	
T02 TEMIC	YMNFP	←	KORANDO	'98 →'10	
ORIGINAL		T00YMNFP	REXTON KORANDO	'03 →'05 '10 →	

SUBARU



P
B | 24K

HF60P

HUF

TX2	HF60P	←	G3X JUSTY	'04 →	 LS7 + TPX LS8

SUBARU



P
B | 24A

X...
1-9000
NS5P

NISSAN

T01 T05	NS5P	←	IMPREZA LEGACY OUTBACK	'96 → '00 '96 → '98 '96 → '98	

SUBARU

P
N | 24K

T....1-3000

SUB1P

SUBARU



TX2

SUB1P



B9 TRIBECA
FORESTER
IMPREZA
LEGACY
OUTBACK

'08 →
'08 →
'08 →
'04 →
'04 →

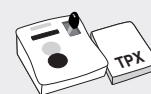

LS7 + TPX
LS8

SUBARU

P
B | 24K

.....1-22185

SUB2P

SUBARU



TX2

SUB2P



B9 TRIBECA
BAJA
FORESTER
IMPREZA
LEGACY
LIBERTY
OUTBACK
WRX

'06 → '08
'05 →
'98 → '07
'00 → '07
'98 → '03
'98 →
'98 → '03
'00 →

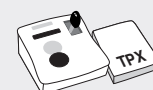

LS7 + TPX
LS8

SUBARU



P
B | 24H



U...
1-2000
SZ11P

SUZUKI

TX1	SZ11P	←	JUSTY	'96 →	 LS7 LS8

SUBARU

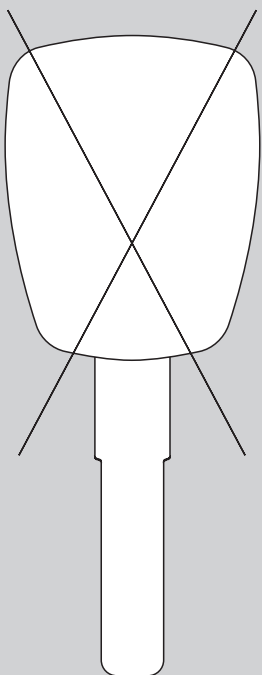

ORIGINAL

			IMPREZA	'08 →	

SUZUKI

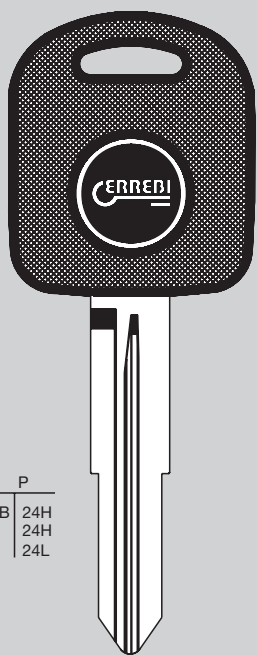

P
B 24H
24H
24L

18100-19229

SZ10RP

SZ10P

SUZUKI

TX1	SZ10RP	←	ALTO BALENO GRAND VITARA JIMNY SWIFT VITARA WAGON R	'96 → '02 '96 → '01 '96 → '02 '99 → '02 '96 → '05 '96 → '02 '98 → '00	 LS7 LS8
TX2	SZ10P	←	ALTO	'02 → '08	 LS7 + TPX LS8
TX2	SZ10RP	←	IGNIS JIMNY	'00 → '08 '02 → '06	
TX4	SZ10RP	←	GRAND VITARA VITARA	'02 → '08 '02 → '08	 LS7 + TX4 TECH LS8

SUZUKI

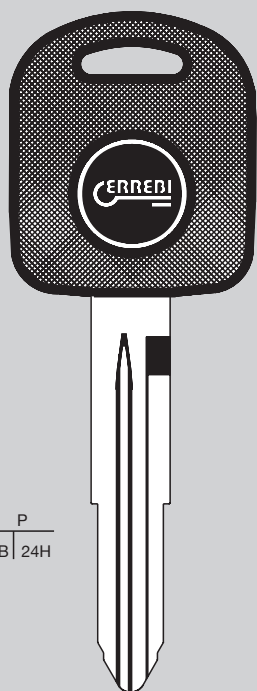

P
B 24H

U...
1-2000

SZ11P

SUZUKI

TX1	SZ11P	←	ALTO BALENO ESCUDO SWIFT VITARA	'96 → '02 '96 → '01 '96 → '96 → '05 '96 → '02	 LS7 LS8

SUZUKI

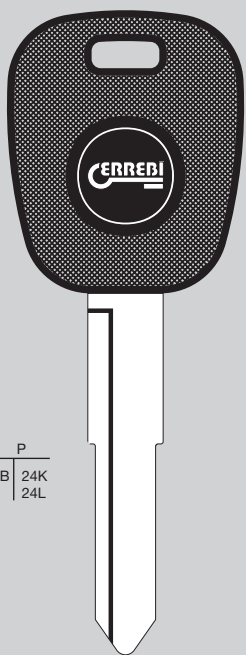

P
B | 24K
24L

SZ15P

SUZUKI

TX2	SZ15P	←	IGNIS JIMNY	'00 → '08 '06 →	 LS7 + TPX LS8
TX4	SZ15P	←	ALTO GRAND VITARA SPLASH SWIFT SX4	'09 → '08 → '08 → '05 → '06 →	 LS7 + TX4 TECH LS8

SUZUKI

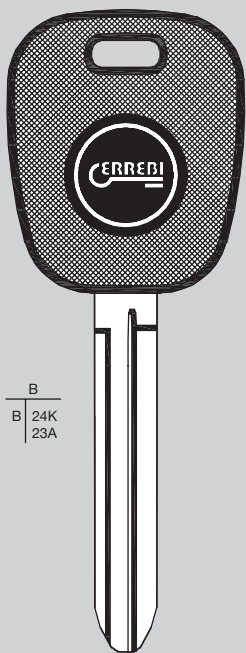

B
B | 24K
23A

TY37RPB

TOYOTA

TX2	TY37RPB	←	LIANA	'01 →	 LS7 + TPX LS8
ORIGINAL		T00TY37RPB	SWIFT	'05 →	

SUZUKI

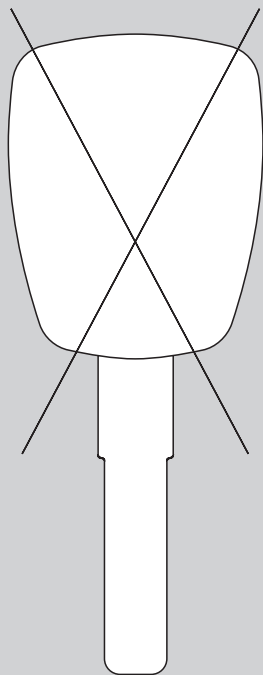

ORIGINAL			AERIO FORENZA WAGON R	'05 → '04 → '00 →	

SUZUKI MARUTI

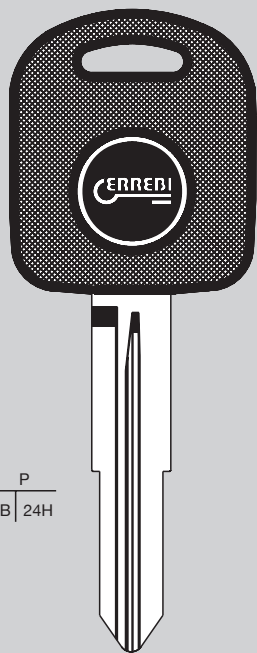

18100-19229

SZ10RP

SZ10P

SUZUKI

TX2	SZ10P	←	ALTO	'07 → '10	 LS7 + TPX LS8
TX2	SZ10RP	←	VERSA WAGON R ZEN ESTILO	'07 → '10 '07 → '10 '07 → '10	

SUZUKI MARUTI

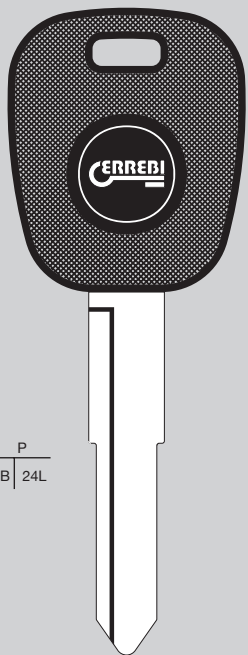

P
B | 24L

SZ15P

SUZUKI

TX4	SZ15P	←	ALTO K10 A-STAR RITZ SWIFT SX4 WAGON R	'10 → '07 → '07 → '07 → '07 → '07 →	 LS7 + TX4 TECH LS8

SUZUKI MARUTI

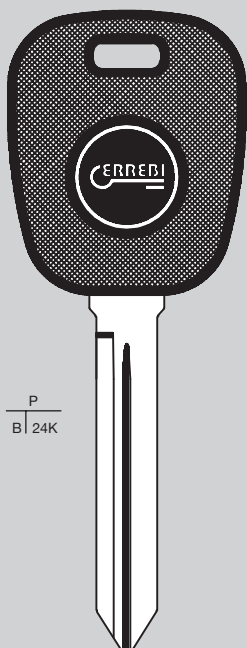

P
B | 24K

SZ17P

SZ17RP

SUZUKI

TX2	SZ17P	←	800 CAR	'07 →	 LS7 + TPX LS8
TX2	SZ17RP	←	ESTEEM OMNI	'07 → '10 '07 → '10	

TATA

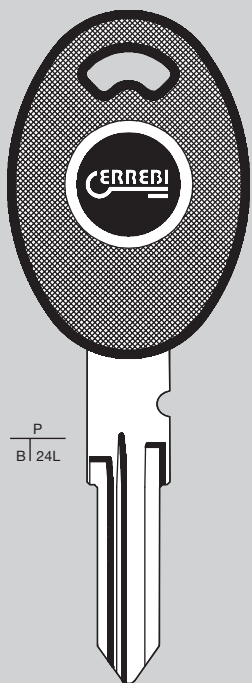

TAT1P

TATA

TX4	TAT1P	←	ARIA INDICA VISTA INDIGO MANZA		 LS7 + TX4 TECH LS8

TATA

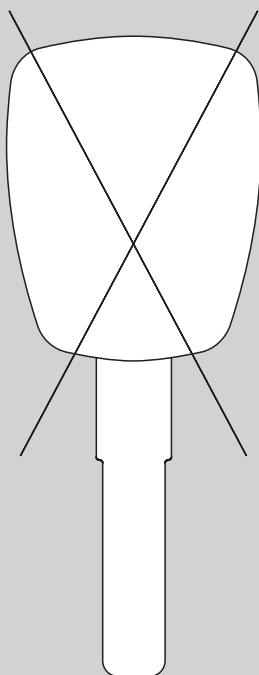

ORIGINAL

			SAFARI	'99 →	 CAR CONCESSIONARY

TOYOTA

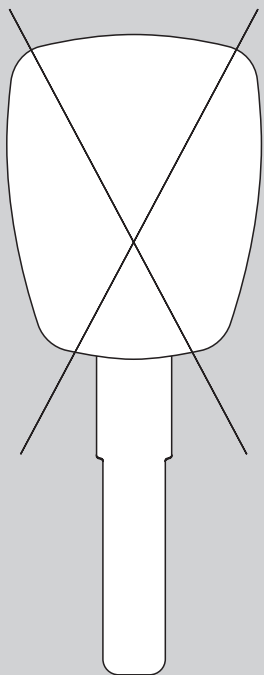

ORIGINAL

AURIS

'07 →

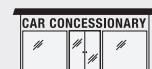

AVALON

'03 →

PRADO

'05 →

SEQUOIA

'04 →

TACOMA

'05 →

TUNDRA

'05 →

URBAN

'09 →

YARIS

'11 →

TOYOTA

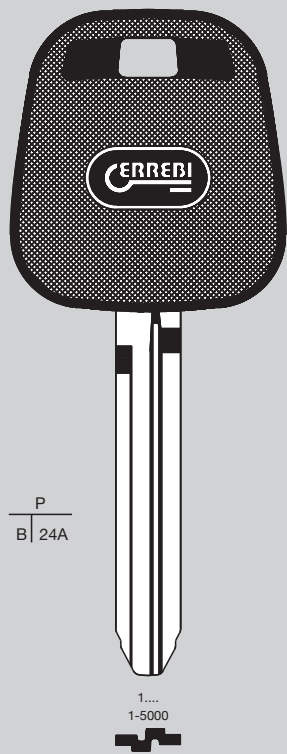

P
B | 24A

1....
1-5000

TY37RP

TOYOTA



T01

TY37RP



CARINA

'96 →



T05

CELICA

'96 → '99

TOYOTA



P
B | 24H



TY37RP

TOYOTA

TX1	TY37RP	←	4 RUNNER AVALON AVENSIS VERSO CALDINA CAMRY CELICA CENTURY COLORADA COROLLA ECHO VERSO ESTIMA GAIA HIACE HIGHLANDER HILUX IPSUM KLUGER LANDCRUISER MARK 2 PICNIC PRADO PREVIA PRIUS PRONARD RAV 4 SEQUOIA SIENNA SOLARA VEROSSA	'99 → '03 '98 → '04 '01 → '03 '02 → '04 '96 → '05 '00 → '05 '98 → '97 → '96 → '06 '02 → '05 '01 → '03 '99 → '04 '95 → '06 '01 → '03 '99 → '04 '96 → '03 '00 → '06 '96 → '03 '96 → '04 '00 → '03 '00 → '03 '00 → '02 '96 → '04 '01 → '03 '99 → '03 '99 → '03 '01 → '04	 LS7 LS8

TOYOTA



P
B | 24K

1...
1-5000

TY37RP

TOYOTA

TX2	TY37RP	←	4 RUNNER ALPHARD AURION AURIS AVALON XL/XLS CAMRY COROLLA DYNA ESTIMA FJ CRUISER FORTUNER FUN CARGO HIACE HIGHLANDER HILUX HIMIKA INNOVA KIJANG IPSUM IQ ISIS IST KLUGER LANDCRUISER MARK X MATRIX NOAH OPEN DECK PICNIC PLAZ PREVIA PRIUS RAUM RAV 4 REGIUSACE REIZ SEQUOIA SIENNA SIENTA SOLARA T.U.V. TACOMA TARAGO TOYOACE TUNDRA VANGUARD VIOS VITZ VOXY WISH YARIS	'03 → '03 → '06 → '06 → '05 →'11 '06 → '05 →'11 '08 → '03 → '07 → '07 → '03 →'05 '07 → '04 → '05 → '06 → '05 → '03 → '08 → '03 → '03 → '03 → '03 → '04 → '05 → '04 → '00 →'05 '03 →'08 '03 →'05 '03 →'08 '04 →'08 '03 → '05 → '07 → '05 → '03 →'11 '04 → '03 → '04 → '03 → '05 →'11 '03 →'08 '08 → '07 →'11 '05 → '07 → '03 → '04 → '04 → '07 →'11	 LS7 + TPX LS8

TOYOTA









P
B | 24H
24K

G/P/X...1-2000

TY40RP

TOYOTA

					
TX1	TY40RP	←	ECHO MR2 PLAZ YARIS	'99 → '05 '97 → '07 '99 → '02 '99 → '05	 LS7 LS8

TOYOTA









A
B | 24H

G/P/X...1-2000

TY40RPA

TOYOTA

					
T01 T05	TY40RPA	←	STARLET	'97 →	

TOYOTA



P
B | 24A

S...1-2878
TY42PA

TOYOTA

T01	TY42PA	←	ESTIMA	'97 →	
T05			PASEO	'97 →	
			PREVIA	'97 →	

TOYOTA



P
B | 24H

....
1-5000
TY43P

TOYOTA

TX1	TY43P	←	CELSIOR CENTURY LAND CRUISER 100	'98 → '04 '98 → '98 → '00	 LS7 LS8

TOYOTA



P
B | 24H

N...
0001-2000

TY44RP

TOYOTA

TX1	TY44RP	←	COROLLA	'96 → '99	 LS7 LS8

TOYOTA



P
B | 24H
24K

....1-13284

TY45P

TOYOTA

TX1	TY45P	←	AVENSIS CARINA YARIS	'98 → '00 '96 → '00 '99 → '05	 LS7 LS8
TX2	TY45P	←	AURIS AVENSIS COROLLA COROLLA (RSA) YARIS	'07 → '00 → '99 → '06 '08 → '05 → '11	 LS7 + TPX LS8

TOYOTA



P
B | 24H

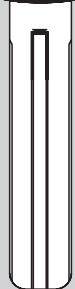

TY47P

TOYOTA

TX1	TY47P	←	ARISTO BREVIS CELSIOR CROWN LAND CRUISER PRADO ORIGIN PROGRESS NC 300 WINDOM	'98 → '05 '01 → '07 '98 → '04 '99 → '05 '00 → '02 '00 → '98 → '06 '01 → '04	 LS7 LS8

TOYOTA



P
N | 24K

VA1P

VALEO

TX2	VA1P	←	AYGO	'05 →	 LS7 + TPX LS8

VOLKSWAGEN



P
B | 24A
24D
24K

AH...
1-8154
1001-9282

HF44P

HUF

T01	HF44P	←	CADDY	'95 → '98	
T05			GOLF III	'95 →	
			PASSAT	'95 → '97	
			POLO	'95 → '98	
			TRANSPORTER	'97 → '98	
			VENTO	'95 →	
TX3	HF44P	←	CADDY	'98 → '00	
			TRANSPORTER	'98 → '00	
T14	HF44P	←	CADDY	'00 →	

VOLKSWAGEN



P
B | 24B

AH...
1-8154
1001-9282

HF55P

HUF

T01	HF55P	←	PASSAT	'97 → '98	
T05			QUANTUM	'97 → '98	
			SHARAN	'95 → '98	

VOLKSWAGEN



P
B 24C
24K

AH...
1-8154
1001-9282

HF55P

HUF

TX3	HF55P	←	GOLF IV LUPO POLO SHARAN TRANSPORTER	'00 → '04 '98 → '98 → '02 '98 → '02 '01 → '04	 LS7 + TPX LS8
T08	HF55P	←	BORA EUROVAN GOLF IV JETTA NEW BEETLE PASSAT QUANTUM SHARAN W8	'98 → '00 → '98 → '00 → '04 '98 → '98 → '04 '98 → '02 → '09 '02 →	 TRACK 7

VOLKSWAGEN



P
B 24C
24D
24E

AH...
1-8154
1001-9282

HF55P

HUF

T08	HF55P	←	PHAETON POLO	'04 → '02 → '05	 TRACK 7
T14	HF55P	←	LUPO POLO SHARAN	'00 → '00 → '02 '00 →	
T23	HF55P	←	EOS GOLF V INDIVIDUAL JETTA PASSAT POLO SCIROCCO TIGUAN TOURAN TUAREG	'06 → '04 → '04 → '05 → '05 → '05 → '09 → '07 → '03 → '03 →	 (****) Pin code

VOLKSWAGEN

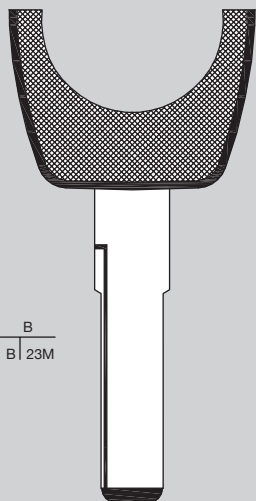

HF55PB

HUF

ORIGINAL		T00HF55PB	PASSAT	'97 → '04	

VOLKSWAGEN

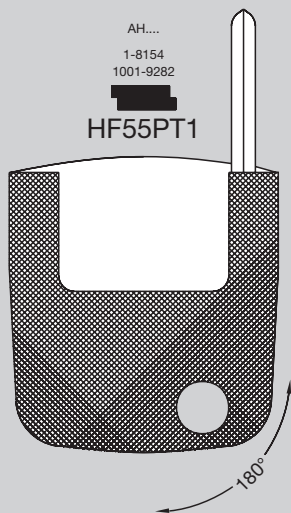

HF55PT1

HUF

ORIGINAL		T00HF55PT1	BORA EUROVAN FOX GOLF IV JETTA LUPO NEW BEETLE PASSAT POLO SCIROCCO SHARAN	'98 → '00 → '05 → '98 → '00 → '04 '98 → '00 '98 → '98 → '04 '98 → '00 '09 → '98 → '00	

VOLKSWAGEN

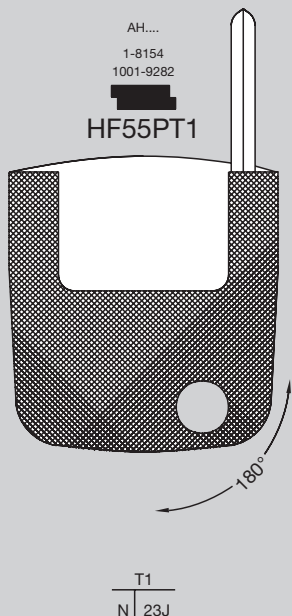

HUF

ORIGINAL		T00HF55PT1	LUPO PHAETON POLO POLO SHARAN	'00 → '04 → '00 →'02 '02 →'05 '00 →	
			EOS GOLF V JETTA PASSAT POLO TIGUAN TOURAN TUAREG	'06 → '04 → '05 → '05 → '05 → '07 → '03 → '03 →	 (****) Pin code

VOLKSWAGEN

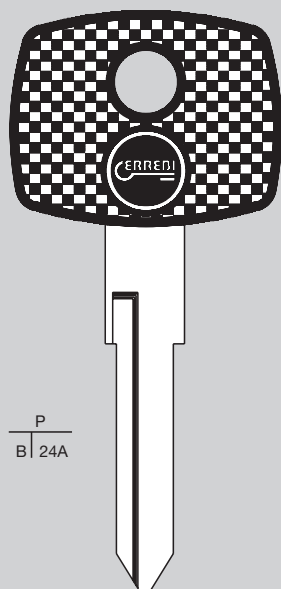

YMOS

TEMIC	T02	YMNFP	← LT28 LT35	'00 → '00 →	

VOLKSWAGEN

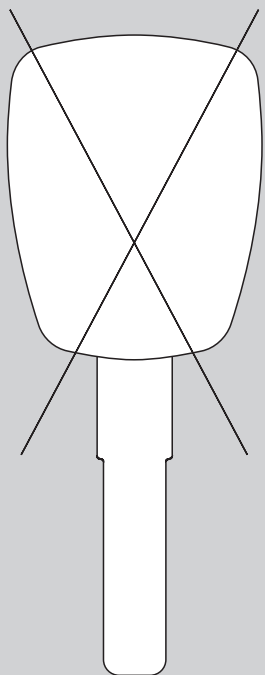

ORIGINAL			CRAFTER GOLF VI ROUTAN TOUAREG	'06 → '08 → '08 → '03 →	

VOLKSWAGEN (BR)

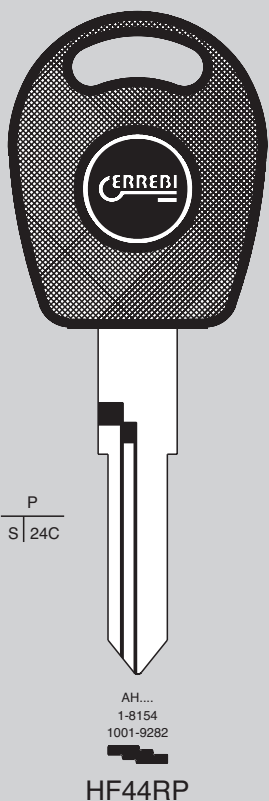

T08	HF44RP	←	GOL KOMBI PARATI SAVEIRO	'99 → '04 '99 → '99 → '99 →	 TRACK 7

HUF

VOLKSWAGEN (BR)

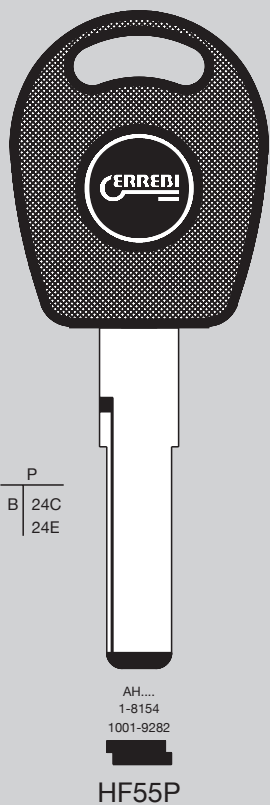

HUF

T08	HF55P	←	GOL GOLF SPACE FOX	'05 → '08 '98 → '05 →	 TRACK 7
T23	HF55P	←	GOL VOYAGE	'09 → '09 →	 CAR CONCESSIONARY (*****) Pin code

VOLKSWAGEN (BR)

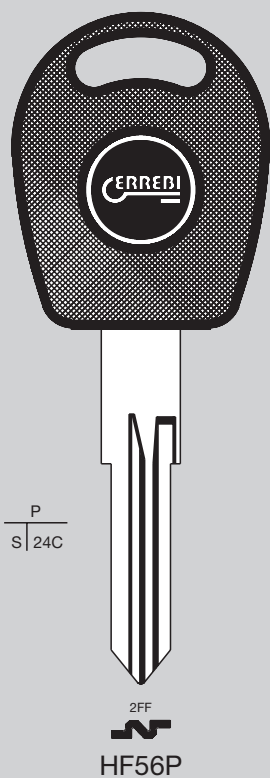

HUF

T08	HF56P	←	GOL KOMBI PARATI SAVEIRO	'99 → '04 '99 → '99 → '99 →	 TRACK 7

VOLKSWAGEN (USA)



P
B | 24E

AH...
1-8154
1001-9282

HF55P

HUF

T23	HF55P	←	EOS GOLF JETTA PHAETOM RABBIT TOUAREG	'07 → '08 '06 → '06 → '04 → '06 → '04 →	 (****) Pin code

VOLVO



P
B | 24B
23B

DN-DH...
6001-8000

HF49PA

HUF

T01 T05	HF49PA	←	S40 V40	'96 → '03 '96 → '98	
ORIGINAL		T00HF49PA	V40	'98 →	

VOLVO

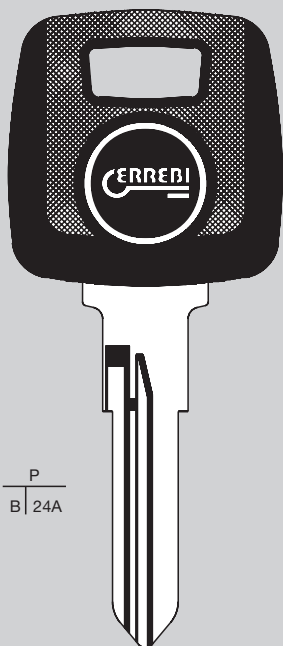







P
B | 24A

1A AL 4A...
1B AL 4B...
0-999
5A-5B...
0-746

NE61P

NEIMAN

					
T01	NE61P	←	940	'96 →	
T05			POLAR	'96 →	

VOLVO

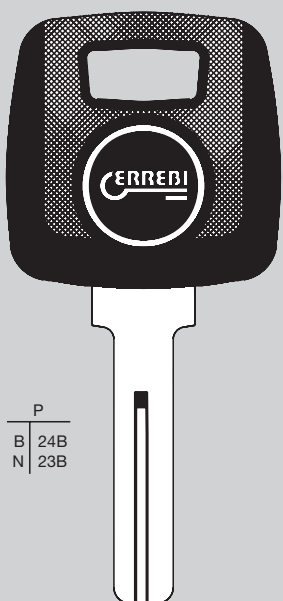







P
B | 24B
N | 23B

1 AL 5V
1-12295







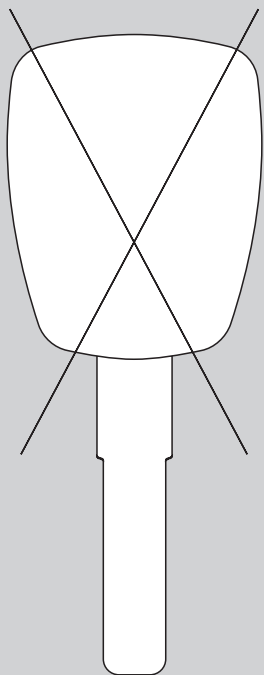

NE70P

NEIMAN

					
T01	NE70P	←	850	'96 →	
T05			960	'96 →	
			C70	'97 → '98	
			S70	'97 → '98	
			V70	'97 → '98	
ORIGINAL		T00NE70P	S60 S80 XC70	'01 → '99 → '03 →	

VOLVO



					
ORIGINAL			C30	'07 →	
			C70	'98 →	
			S40	'04 →	
			S70	'98 →	
			V50	'04 →	
			V70	'98 →	
			XC60	'08 →	
			XC90	'03 →	



Camion
Trucks

DAF



P
B | 24C

..1/9...
1/9.....A/Z
.1/9.....A/Z
..1/9...A/Z
...1/9...A/Z
....1/9..A/Z
.....1/9.A/Z
.....1/9.A/Z
....1/9..A/Z A/Z
M-N-P-R-S

NE79P

NEIMAN

T08	NE79P	←	CF LF XF	'02 → '02 → '02 →	

FORD

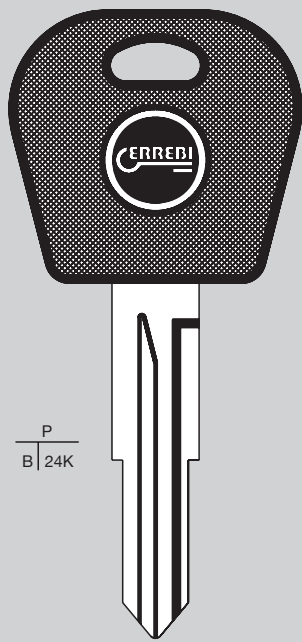

P
B | 24K

V...
1-1200
DW1P

DAEWOO

TX2	DW1P	←	LDV	'08 →	 LS7 + TPX LS8

FORD



P
B | 24H

...X
1-1706
FD16RP

STRATTEC

TX1	FD16RP	←	F-SERIES HEAVY TRUCKS	'99 → '03 '00 → '03	 LS7 LS8

FORD

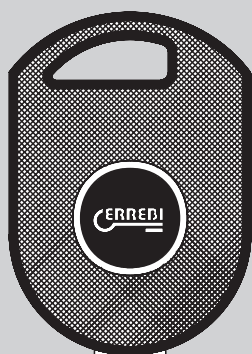

P
B | 24K

FD21P

STRATTEC

TX2	FD21P	←	F-SERIES HEAVY TRUCKS	'04 → '04 →	 LS7 + TPX LS8

IVECO



P
B | 24L

N....6001-7000
J....3001-6732
V...1-3051
V....5001-8058
AB....6001-6891

GB9RP

GIOBERT-TRW-SIPEA

TX4	GB9RP	←	35 C11 EUROSTAR NEW DAILY S2000	'00 → '98 → '98 → '98 →	 LS7 + TX4 TECH LS8

IVECO



P
B | 24L
24K

GB18P

GIOBERT-TRW-SIPEA

TX4	GB18P	←	EUROCARGO STRALIS	'02 → '07 '02 →	 LS7 + TX4 TECH LS8
TX2	GB18P	←	EUROCARGO	'08 →	 LS7 + TPX LS8

LDV

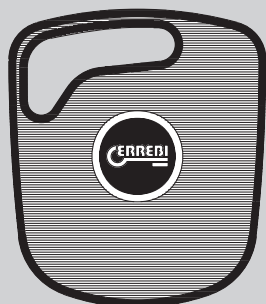

P
S | 24H
24K

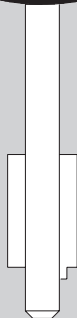

YM25P

CHUBB - YMOS

TX1	YM25P	←	CONVOY CUB	'98 → '00 '98 → '00	 LS7 LS8
TX2	YM25P	←	CONVOY CUB	'00 → '00 →	 LS7 + TPX LS8

MAN



P
N | 24B



HF63P

HUF

T01 T05	HF63P	←	TGA	'03 →	

MERCEDES

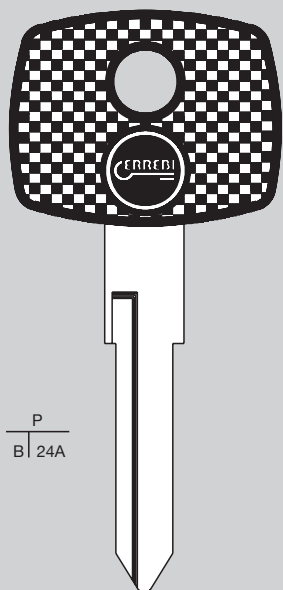

P
B | 24A

HM...1-1200
2501-3500
4001-5795
5801-7350
NF...1-1200
...NF...
01-99/01/99

YMNFP

HUF

T01	YMNFP	←	ACTROS	'97 →		
T05			ATECO	'98 →		
T02	YMNFP	←	ACTROS ATECO 815	'98 → '98 →		
TEMIC						

NISSAN



P
B | 24L

...1/9...
1/9...A/Z
.1/9...A/Z
..1/9...A/Z
...1/9...A/Z
....1/9...A/Z
.....1/9...A/Z
.....1/9...A/Z
.....1/9...A/Z A/Z
M-N-P-R-S

NE79P

NEIMAN

TX4	NE79P	←	INTERSTAR KUBISTAR PRIMASTAR	'02 → '03 → '03 →		
					LS7 + TX4 TECH LS8	

NISSAN



P
B | 24K

X...
1-9000
NS5P

NISSAN

TX2	NS5P	←	ATLEON CABSTAR	'02 → '00 → '02	 LS7 + TPX LS8

NISSAN



P
B | 24L

.....
1-22185
NS8P

NISSAN

TX4	NS8P	←	CABSTAR	'02 →	 LS7 + TX4 TECH LS8

RENAULT



P
B | 24A
24L

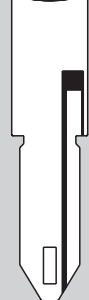

...1/9...
1/9...A/Z
.1/9...A/Z
..1/9...A/Z
...1/9...A/Z
....1/9...A/Z
.....1/9...A/Z
...1/9...A/Z A/Z
M-N-P-R-S



NE79P

NEIMAN

T01 T05	NE79P	←	KERAX	'00 →	
TX4	NE79P	←	PREMIUM	'06 →	 LS7 + TX4 TECH LS8

SCANIA



P
B | 24K



HF72P

HUF

TX2	HF72P	←	164 R-SERIES	'04 → '05 →	 LS7 + TPX LS8

STELRING

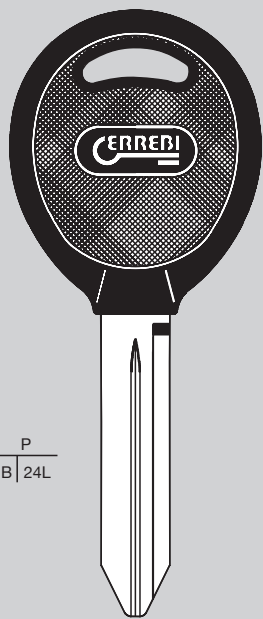

P
B | 24L

L...
1-3580
CY62P

CHRYSLER

TX4	CY62P	←	BULLET	'08 →	 LS7 + TX4 TECH LS8

VOLVO

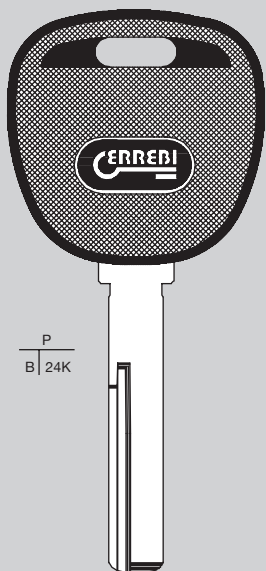

P
B | 24K

HF49P

HUF

TX3	HF49P	←	SX 12	'07 →	 LS7 LS8



Motociclette
Motorcycles

APRILIA



P
B | 24A

8001-9554

ZA18RP

ZADI

T02	ZA18RP	←	ATLANTIC 500 SCARABEO 500	'03 → '03 →	

APRILIA

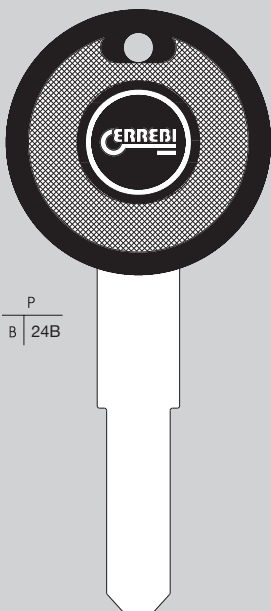

P
B | 24B

ZA21P

ZADI

T02	ZA21P	←	RSV 1000 TUONO 1000R	'04 → '04 →	

BMW

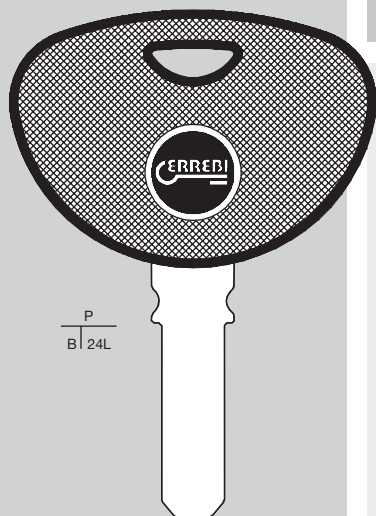

P
B | 24L

HF71P

HUF

TX4	HF71P	←	F650 F800 K1200 R1200 RT	'08 → '06 → '05 → '05 →	 LS7 + TX4 TECH LS8

DERBI

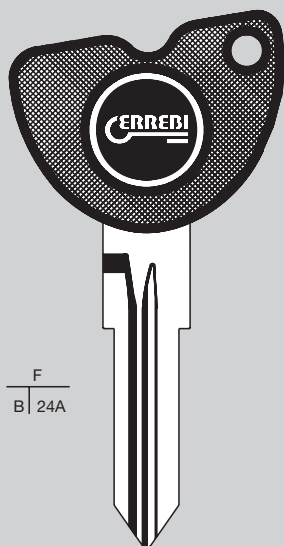

F
B | 24A

W...
1-9640
GB14RPF

GIOBERT

T02	GB14RPF	←	BOULEVARD 150	'03 →	

DUCATI



P
B | 24A

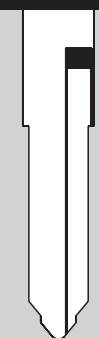

KW16P

KAWASAKI

T02	KW16P	←	600 MONSTER 600 S SPORT 620 MONSTER DARK 749 800 SPORT 900 MONSTER 999 999 R 999 S	'01 → '01 → '03 → '03 → '03 → '01 → '03 → '03 → '03 →	
TEMIC					

DUCATI



P
B | 24A

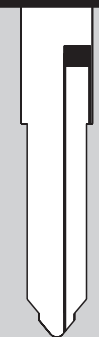

KW16P

KAWASAKI

T02	KW16P	←	1000 DS MONSTER S2R MONSTER S4 MONSTER S4R ST3 ST4S	'03 → '05 → '01 → '05 → '05 → '02 →	
TEMIC					

GILERA

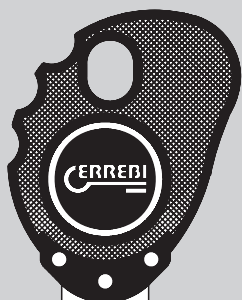







P
B | 24A

8001-9554

 ZA18RP

ZADI

						
T02	ZA18RP	←	X-MAX 250	'05 →		
TEMIC						

GILERA

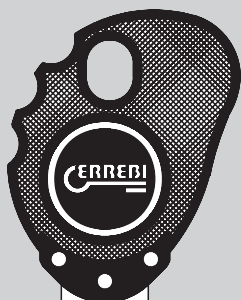







P
B | 24A

8001-9554

 ZA19RP

ZADI

						
T02	ZA19RP	←	NEXUS 250	'07 →		
TEMIC						

GILERA



P
B | 24B

GB18P

GIOBERT-TRW-SIPEA

T02	GB18P	←	FUOCO GP 800 NEXUS 500	'06 → '06 → '06 →	
TEMIC					

HONDA



P
B | 24L

HD55P

HONDA

TX4	HD55P	←	CBR 600 F CBR 600 RR CBR 900 CBR 1000 CBR 1100 F GOLD 2800 HORNET NT 650 V NT 700V NX 650V RUNE SHADOW 750 SILVER WIND ST 1300 SW T400 VARADERO VT 750 C4 VTX 1800 X11	'99 → '03 → '03 → '04 → '99 → '01 → '03 → '03 → '06 → '99 → '03 → '03 → '08 → '09 → '03 → '04 → '03 → '02 → '01 →	 LS7 + TX4 TECH LS8

HONDA

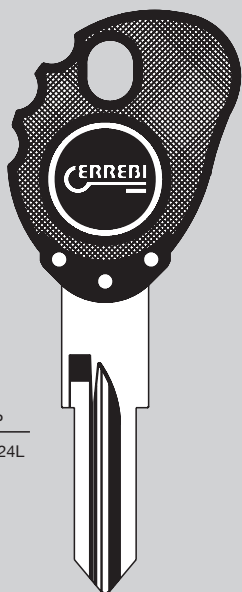

P
B | 24L

8001-9554
Z
ZA19RP

ZADI

TX4	ZA19RP	←	SH 300	'07 →	 LS7 + TX4 TECH LS8

KAWASAKI

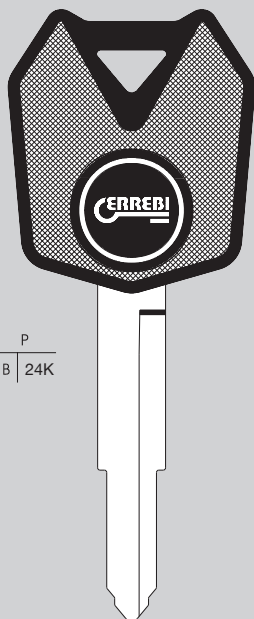

P
B | 24K

Z....
5000-6000
Z
KW18P

KAWASAKI

TX2	KW18P	←	NINJA ZX 6R NINJA ZX 10R Z 750S Z 1000 ZX 1000 ZZR 1400	'06 → '04 → '06 → '04 → '04 → '07 →	 LS7 + TPX LS8

MALAGUTI

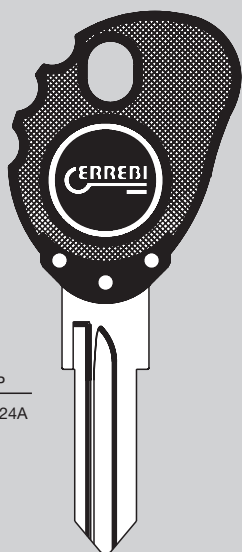

P
B | 24A

8001-9554
TM
ZA18RP

ZADI

T02	ZA18RP	←	FIREFOX F15	'96 →	
TEMIC					

MBK

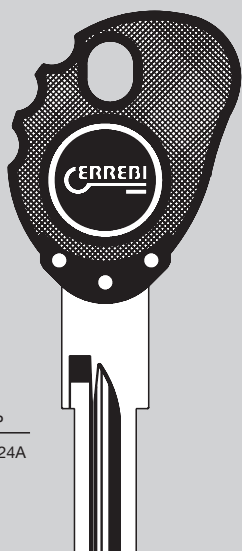

P
B | 24A

8001-9554
TM
ZA19RP

ZADI

T02	ZA19RP	←	BOOSTER	'99 →	
TEMIC					

MBK

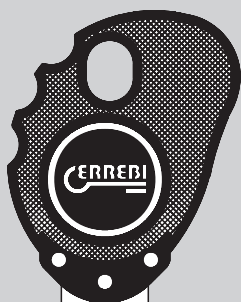

P
B | 24A



8001-9554
NL
ZA19RP

ZADI

T02	ZA19RP	←	BOOSTER CT 50 DOODO FIZZ FLIPPER NEW FLAME NEW SORRISO NITRO OVETTO SKYLINER STUNT CAT TARGET THUNDER XC 125 XC 250	'97 → '99 '95 → '95 → '95 → '95 → '95 → '95 → '95 → '95 → '95 → '95 → '95 → '95 → '95 → '95 → '95 → '95 →	
TEMIC					

MOTO GUZZI



P
B | 24B



ZA21P

ZADI

T02	ZA21P	←	BELLAGIO GRISO NORGE	'06 → '06 → '06 →	
TEMIC					

PEUGEOT



D
B | 24A



NE76PD

NEIMAN

T02	NE76PD	←	ALISE ELISEO SPEEDFIGHT	'98 → '98 → '97 →	
TEMIC					

PIAGGIO



F
B | 24A



W...
1-9640
GB14RPF

GIOBERT

T02	GB14RPF	←	BEVERLY 200 BEVERLY 250 BEVERLY 500 FLY 150 LIBERTY VESPA (All models) X9 500	'03 → '05 → '05 → '05 → '00 → '96 → '05 →	
TEMIC					

PIAGGIO

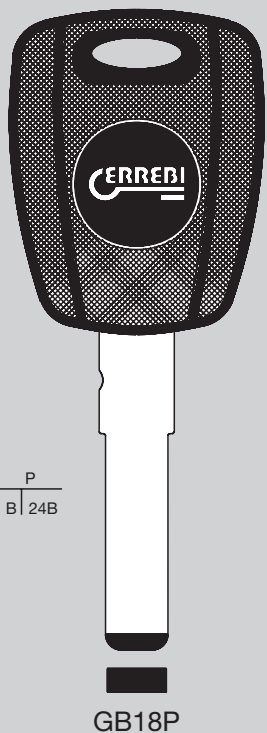

P
B | 24B

GB18P

GIOBERT-TRW-SIPEA

T05	GB18P	←	MP3 X8 XEVO 400	'06 → '06 → '06 →	

SUZUKI

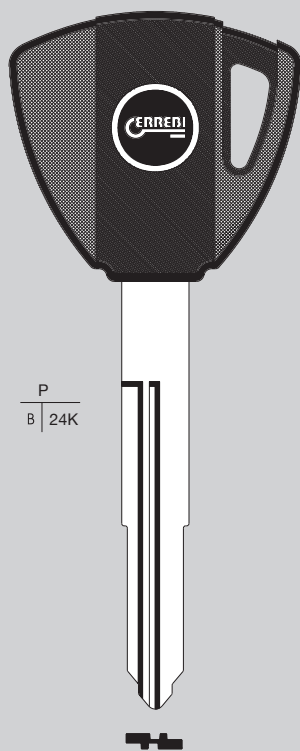

P
B | 24K

SZ16RP

SUZUKI

TX2	SZ16RP	←	BURGMAN GSF BANDIT GSX-R 600 GSX-R 750 GSX-R 1000 HAYABUSA V - STROM 650 V - STROM 1000	'04 → '07 → '06 → '07 → '06 → '08 → '07 → '07 →	 LS7 + TPX LS8

YAMAHA

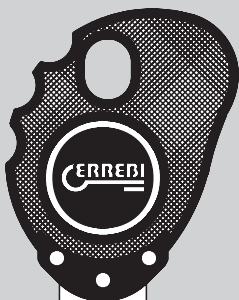

P
B 24A
24K

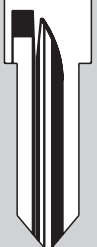

8001-9554
ZL
ZA19RP

ZADI

T05	ZA19RP	←	AEROX NEOS X-MAX 250	'98 → '98 → '05 →'09	
TX2	ZA19RP	←	X-MAX 125	'06 →	 LS7 + TPX LS8

YAMAHA



P
B 24K

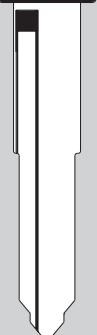

ZL
YA34RP

YAMAHA

TX2	YA34RP	←	BT1100 Bulldog FJR 1300 FZ1 FZ6 FZ8 FZS1000 Fazer MAJESTY 400 MT-01 MT-03 TDM 600 TDM 900 T-MAX 500	'05 → '05 → '06 → '04 → '10 → '05 → '05 → '05 → '06 → '05 → '04 → '05 →	 LS7 + TPX LS8

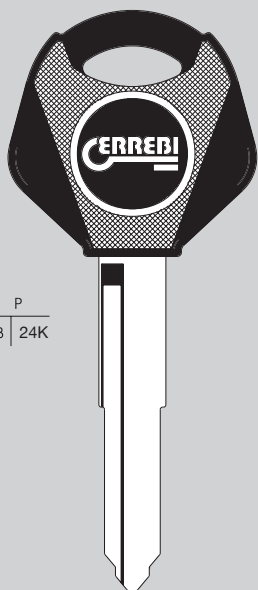

YA34RP

YAMAHA

TX2	YA34RP	←	XJR 1300 X-MAX 250 XP500 XT 660R XT 660Z TENERÈ XT 1200Z SUPER TENERÈ XTR XTX XVS 650A Drag Star XVS 1100A Drag Star YP400 YVS A Drag Star YZF R1 YZF R6 ZTR	'04 → '04 → '04 → '04 → '08 → '10 → '04 → '04 → '04 → '04 → '04 → '05 → '03 → '04 →	 LS7 + TPX LS8